



ALL IN ONE

SUPPLIES



CATALOGUE

Instrument Maintenance Sterilization

Gefäße aus Edelstahl
Stainless Steel Receptacles
Recipienti in acciaio inossidabile
Recipientes de acero inoxidable
Réipients en acier inoxydable

Nadeldose
Needle case
Scatola per aghi
Caja para agujas
Boîte à aiguilles



BI-BS-1
Ø 78 mm h 15 mm

Verbandstofftrommeln
Dressing sterilizing drums
Cestelli cilindrici
Caja para esterilización
Boîte à stérilisation



BI-CS-12 125x125 mm
BI-CS-15 150x150 mm
BI-CS-19 190x145 mm

Nierenschalen
Kidney bowls
Bacinelle reniformi
Riñoneras
Bassins réniformes

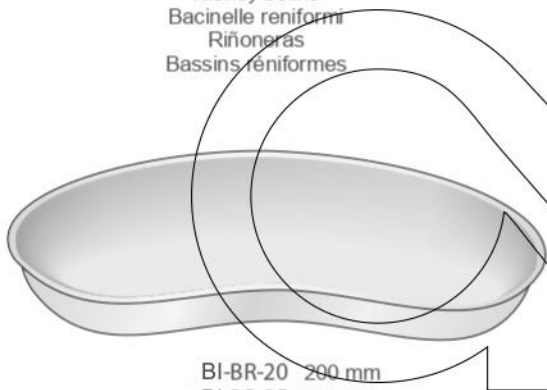

BI-BR-20 200 mm
BI-BR-25 250 mm
BI-BR-28 280 mm

Runder Sterilbehälter mit Ausguss
Round sterile bowl
Capsule inox con fondo piano e becco
Cubetas de acero inoxidable
Cuvettes de acier inoxydable

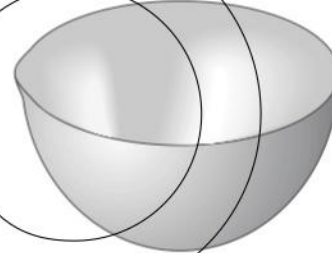

BI-CS-01 Ø 40 mm 15 cc
BI-CS-02 Ø 60 mm 75 cc
BI-CS-03 Ø 60 mm 75 cc
BI-CS-04 Ø 100 mm 325 cc
BI-CS-05 Ø 120 mm 500 cc

Gefäße
Receptacles
Recipiente
Recipientes
Réipients

Mit 7 box
With 7 box
Con 7 box
Con 7 box
Avec 7 box



BI-BS-32
180 x 85 x 20 mm

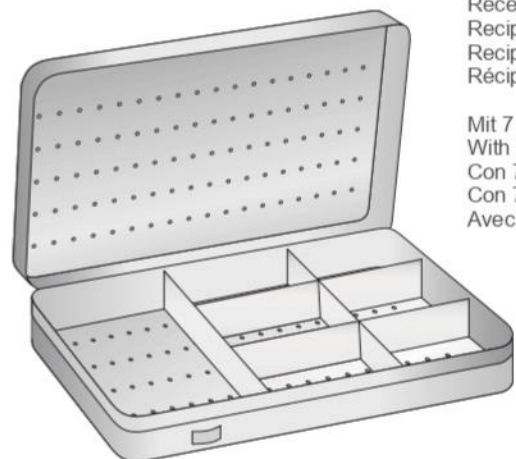

BI-BS-27
150 x 90 x 20 mm

Steri Container
Sterilization Container
Contenitori per sterilizzazione
Contenedores para esterilización
Conteneurs pour stérilisation

Schalen
Trays
Vassoi
Bandejas
Bassins



BI-VS-20 210 x 110 x 25 mm
BI-VS-26 250 x 180 x 30 mm
BI-VS-30 300 x 220 x 30 mm

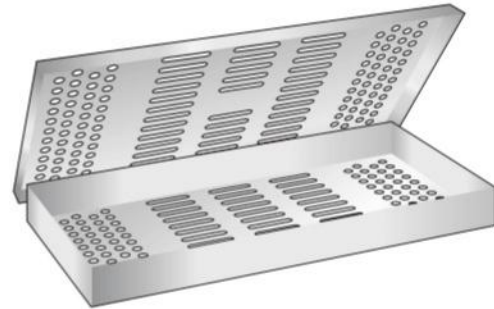

BI-BS-41
275 x 130 x 25 mm

Mit Instrumentehalter und box
With Insert frames and box
Con griglia e scomparti
Con porta instrumentos y box
Avec Porte instruments et box

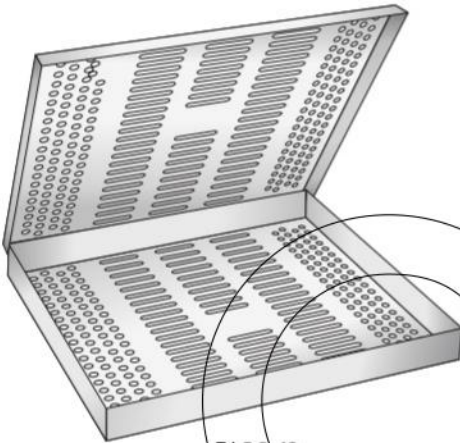

BI-BS-43
285 x 190 x 25 mm

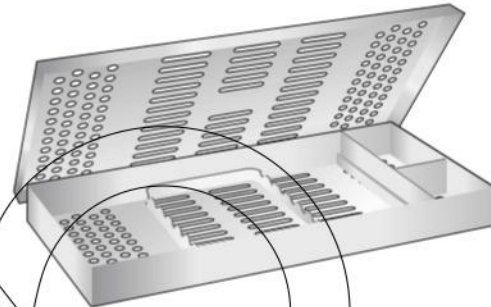

BI-BS-40 275x130x25mm
BI-BS-42 285x190x25mm

Silicon Mat
Silikon Noppenmatten
Tappeti di silicone
Tapiz de silicona
Tapis en silicone

Autoklav
Autoclavable
Autoclavabile
Autoclave
Autoclave

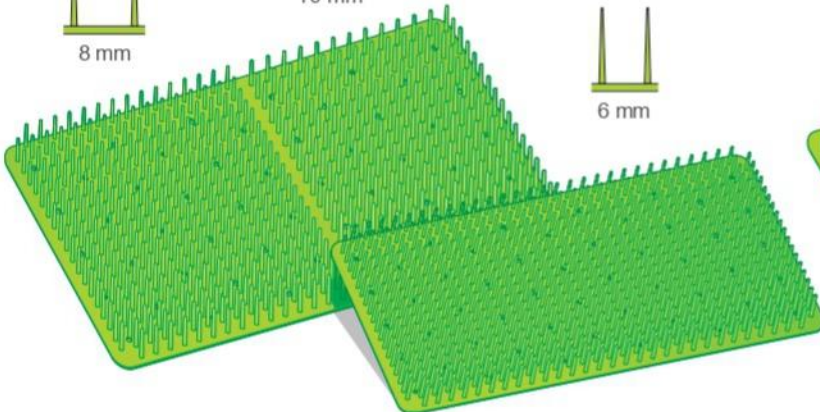

BI-TS-104
270 x 180 mm

BI-TS-103
260 x 120 mm

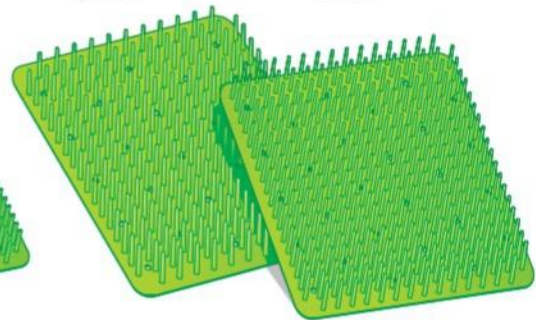

BI-TS-102
135 x 180 mm

BI-TS-101
135 x 180 mm

Steril Container
Sterilization Container
Contentori per sterilizzazione
Contenedores para esterilización
Conteneurs pour stérilisation

Rostfreier Stahl Sterilcontainer mit Silikoneinrichtung
Stainless Steel Sterilization Containers with silicone racks
Contentori per sterilizzazione in acciaio inossidabile con griglia in silicone
Contenedores para esterilización en acero inoxidable con soportes en silicona
Containers pour stérilisation en acier inoxydable avec des supports de silicone

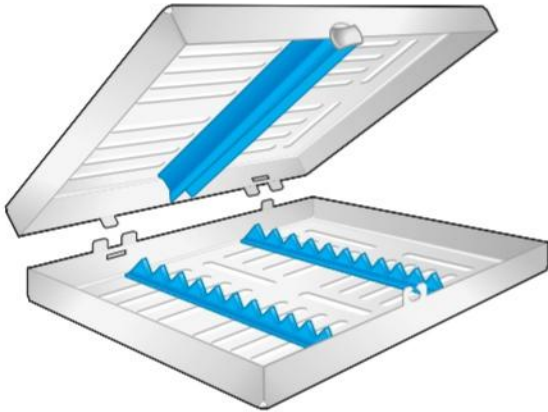

BI-BS-60
185 x 135 x 35 mm
For 10 Instruments

BI-BS-61
290 x 185 x 35 mm
For 20 Instruments

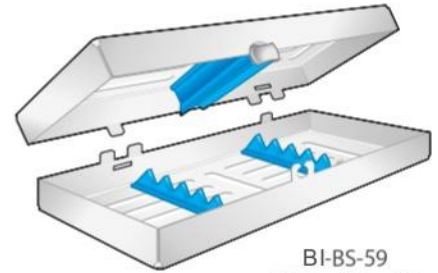

BI-BS-59
185 x 75 x 35 mm
For 5 Instruments

CT-555
CT-560
CT-565



CT-651
CT-652
CT-653



Sterilcontainer mit Deckel- und Bodenperforation, passend in gängige Praxisautoklaven
Containers for sterilization with perforation in lid and bottom, suitable for common practice autoclaves
Contentori dentali con coperchio e fondo perforato, adatti a tutte le autoclavi comuni
Contenedores dentales con tapa y fondo perforados, aptos para autoclaves habituales
Containers sterile, avec perforation du couvercle et du fond, convenant aux autoclaves courants

Silikoneinrichtung für Tray
Silicone Racks for Tray
Griglia in Silicone per Tray
Equipo de silicona para Tray
Aménagement en silicone pour Tray



Alu
Aluminium
Alluminio
Aluminio
Aluminium

CT-555
300 x 140 x 40 mm
CT-651
310 x 190 x 40 mm

CT-560
300 x 140 x 70 mm
CT-652
310 x 190 x 65 mm

CT-565
300 x 140 x 100 mm
CT-653
310 x 190 x 130 mm

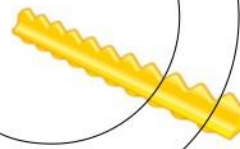

TRANSLUCENT YELLOW
BI-SIL-01
130 mm

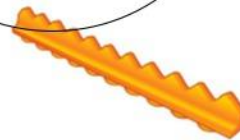

ORANGE
BI-SIL-02
130 mm

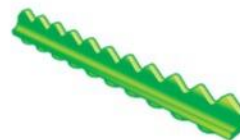

TRANSLUCENT GREEN
BI-SIL-03
130 mm



RUST RED
BI-SIL-04
130 mm

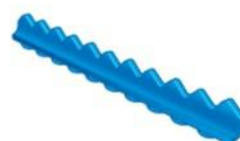

BLUE
BI-SIL-05
130 mm



Aluminium-Tray
 Aluminium Trays
 Tray in alluminio
 Bandejas de aluminio
 Boîtes en aluminium

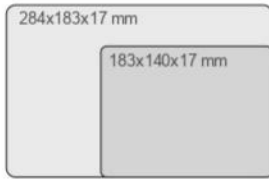

Farbcodiert-Tray-Unterteile für 17 instrumente
 Color-Coded bases for 17 instruments
 Vassoi colorati per 17 strumenti
 Bandejas en colores para 17 instrumentos
 Plateaux colorés pour 17 instruments

Für 17 instrumente
 For 17 instruments
 Per 17 strumenti
 Para 17 instrumentos
 Pour 17 instruments

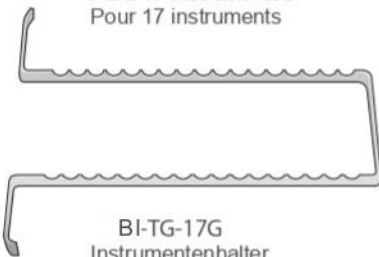

BI-TG-17G
 Instrumentenhalter
 Insert frames
 Griglia Portastrumenti
 Porta instrumentos
 Porte instruments



BI-TG-17A
 284x183x17 mm
 Unterteile allein
 Only base
 Vassoio solo
 Bandeja suelta
 Plateau seul



BI-TG-17R
 284x183x17 mm
 Unterteile allein
 Only base
 Vassoio solo
 Bandeja suelta
 Plateau seul

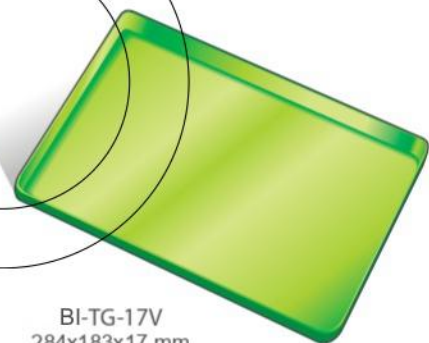

BI-TG-17V
 284x183x17 mm
 Unterteile allein
 Only base
 Vassoio solo
 Bandeja suelta
 Plateau seul

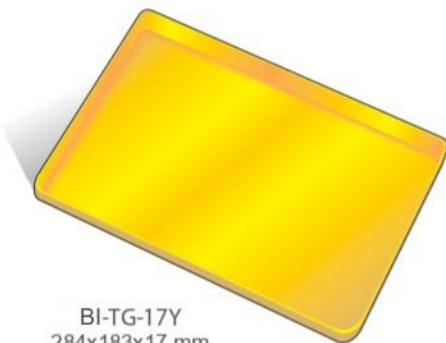

BI-TG-17Y
 284x183x17 mm
 Unterteile allein
 Only base
 Vassoio solo
 Bandeja suelta
 Plateau seul



BI-TG-17B
 284x183x17 mm
 Unterteile allein
 Only base
 Vassoio solo
 Bandeja suelta
 Plateau seul



BI-TG-17C
 288x187x29 mm
 Tray-Deckel, grau
 Lid - Grey only
 Coperchio - Solo argento
 Tapa en color gris
 Couvercle - seulement en gris



Aluminium MIDI Tray
Aluminium MIDI Trays
Tray in alluminio, misura MIDI
Bandejas de aluminio, tamaño MIDI
Boîtes en aluminium, format MIDI

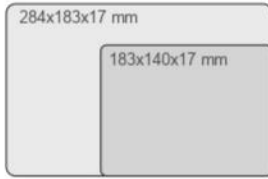

Farbcodiert-Tray-Unterteile für 8 instrumente
Color-Coded bases for 8 instruments
Vassoio colorati per 8 strumenti
Bandejas en colores para 8 instrumentos
Plateaux colorés pour 8 instruments

Für 8 instrumente
For 8 instruments
Per 8 strumenti
Para 8 instrumentos
Pour 8 instruments

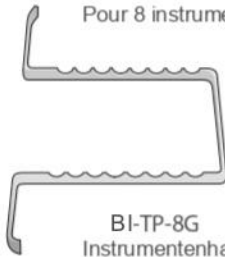

BI-TP-8G
Instrumentenhalter
Insert frames
Griglia Portastrumenti
Porta instrumentos
Porte instruments



BI-TP-8A
183x140x17 mm
Unterteile allein
Only base
Vassoio solo
Bandeja suelta
Plateau seul

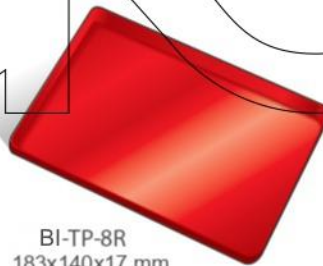

BI-TP-8R
183x140x17 mm
Unterteile allein
Only base
Vassoio solo
Bandeja suelta
Plateau seul

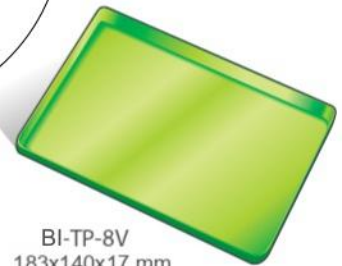

BI-TP-8V
183x140x17 mm
Unterteile allein
Only base
Vassoio solo
Bandeja suelta
Plateau seul

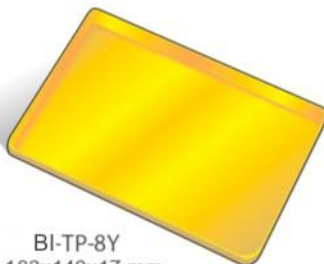

BI-TP-8Y
183x140x17 mm
Unterteile allein
Only base
Vassoio solo
Bandeja suelta
Plateau seul



BI-TP-8B
183x140x17 mm
Unterteile allein
Only base
Vassoio solo
Bandeja suelta
Plateau seul



BI-TP-8C
187x145x25 mm
Tray-Deckel, grau
Lid - Grey only
Coperchio - Solo argento
Tapa en color gris
Couvercle - seulement en gris

Steril Container
 Sterilization Container
 Contenitori per sterilizzazione
 Contenedores para esterilización
 Conteneurs pour stérilisation

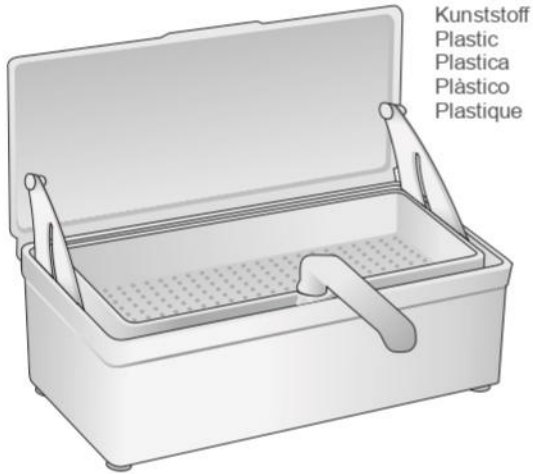

Kunststoff
 Plastic
 Plastica
 Plàstico
 Plastique

BI-BS-100
 255 x 105 x 85 mm

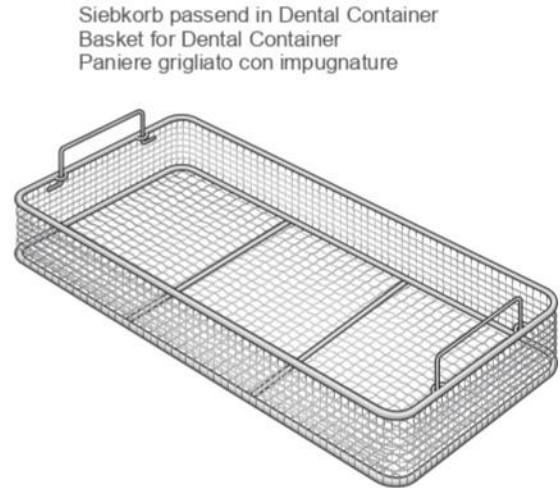

Siebkorb passend in Dental Container
 Basket for Dental Container
 Panniere grigliato con impugnature

BI-CT-650
 265 x 120 x 45 mm

Rostfrei - Stainless steel - Inox - Inoxidable - Inoxydable
 Norm-tray complet mit tray-unterteile, deckel und instrumentenhalter für 23 instrumente
 Instrument tray complete with base, lid and insert frame for 23 instruments
 Portastrumenti completo di vassoio, coperchio e griglia per 23 strumenti
 Bandeja completa de tapa y porta instrumentos para 23 instrumentos
 Boite complete avec plateau et couvercle pour 23 instruments

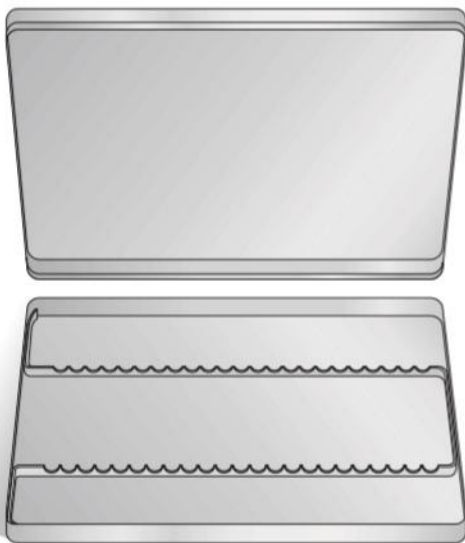

TRAY INOX
 BI-TI
 284 x 183 x 17 mm

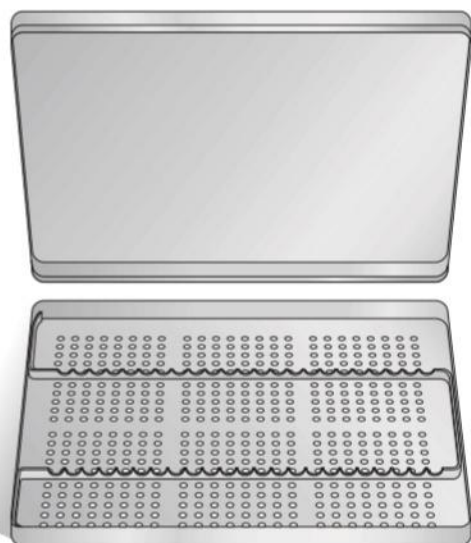



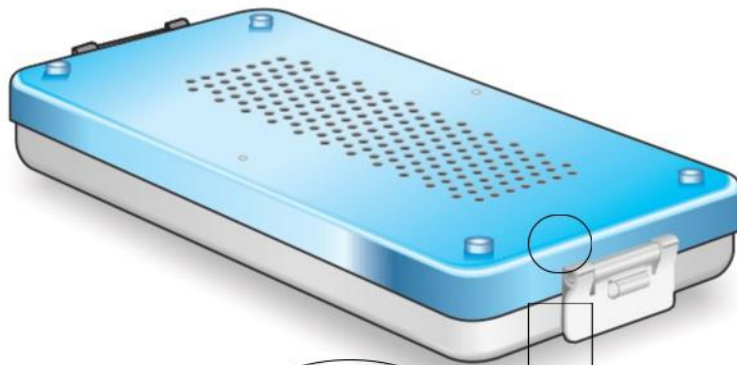

TRAY INOX
 BI-TIF
 284 x 183 x 17 mm

Steril Container
Sterilization Container
Contenitori per sterilizzazione
Contenedores para esterilización
Conteneurs pour stérilisation

Stainless Steel - Aluminium
Rostfrei - Aluminium
Acier inoxydable - Aluminium
Acero inoxidable - Aluminio
Acciaio inossidabile - Alluminio



Small
outside: 300 x 140 x 40 mm
inside: 280 x 130 x 27 mm

-  BI-CT-555N
-  BI-CT-556N
-  BI-CT-557N
-  BI-CT-558N
-  BI-CT-559N

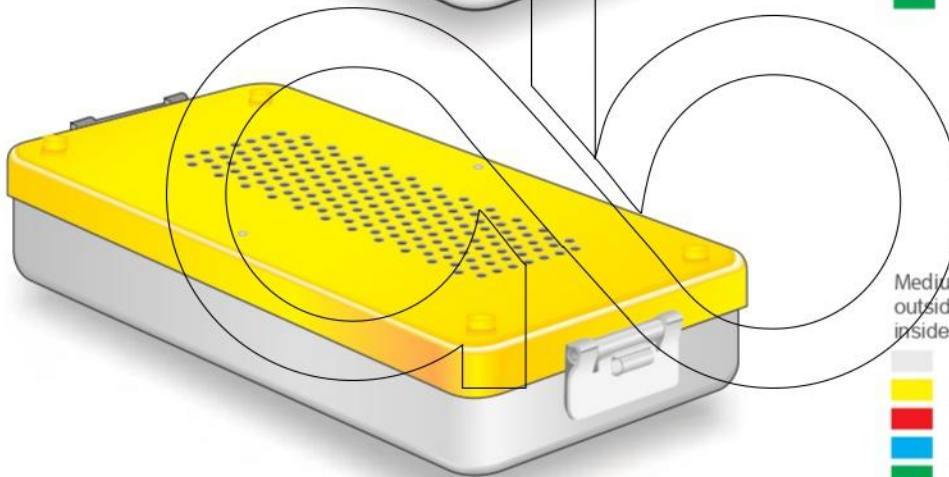





Medium
outside: 300 x 140 x 70 mm
inside: 280 x 130 x 55 mm

-  BI-CT-560N
-  BI-CT-561N
-  BI-CT-562N
-  BI-CT-563N
-  BI-CT-564N



Large
outside: 300 x 140 x 100 mm
inside: 280 x 130 x 84 mm

-  BI-CT-565N
-  BI-CT-566N
-  BI-CT-567N
-  BI-CT-568N
-  BI-CT-569N



Instrumentenpflege
Maintenance of instruments
Mantenimento dello strumentario
Mantenimiento del instrumental
Nettoyage d'instruments

Original Arkansas

Sharpening Stones
Schleifsteine
Pierres à aiguiser
Piedras de afilar
Pietre per affilare

BI-DB-4
ARKANSAS # 4
100 mm

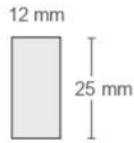

ADM-DB-299
ARKANSAS
conica # 299
90 mm



ADM-DB-96
ARKANSAS # 8
100 x 50 x 13 mm



Teflon Stick for sharpening test
Teflon-Stäbchen für das Schärfe-Test
Bastón de teflon para probar afilado
Bâton en teflon pour tester l'aiguisage
Bastoncino di Teflon per provare affilatura



BI-DB-15
100 mm
8 mm



BI-DB-6A
ARKANSAS # 6A
100 mm

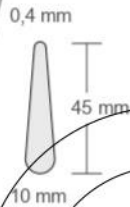

BI-DB-3
INDIA # 6
100 mm

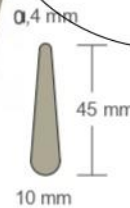

BI-DB-11
155 mm



BI-DB-12
175 mm

Brushes for instruments
Instrumente-Reinigungsbürsten
Brosses pour instruments
Cepillos para instrumentos
Spazzolino per strumenti

Lubricating and sharpening oil SHARPEN OIL

It is a non-coloured oil, which is an indispensable complement for lubricating and manual sharpening of surgical instruments. It should be applied to ensure perfect function and fluid movement of all surgical instruments (on all hinges or all other part which are subject to movement or friction).

Must always be used during all sharpening operations. It is used to activate the abrasive properties of all stones (Arkansas, India, etc.), and to reduce the possibility of overheating the instruments during sharpening.

Special Rubber for Metal
Spezial-Gummi für Metall
Caoutchouc spécial pour métal
Goma especial para metal
Gomme speciali per metalli



BI-DB-07 /
BI-DB-08
Fine / Coarse
50 x 40 x 20 mm

Bacteriostatic Anti-Corrosion Milk

CLEANLACT

Extends your surgical instrument's lifetime. A periodic use of Cleanlact prevents corrosion; it has a bacteriostatic and lubricating action on all instruments; it guarantees perfect maintenance by eliminating eventual stains, halos and browning due to sterilization, disinfection and washing with tap water. Must use periodically, diluted or concentrated (see special instructions on packaging).

Vorbereitung - Nagel scheren
 Preparation - Nail scissors
 Preparazione - Forbici per unghie
 Preparación - Tijeras para uñas
 Préparation - Ciseaux à ongles

Handwaschbürste
 Nail brushes
 Spazzola per unghie
 Cepillo para uñas
 Brosse à ongles



BI-GF-200
 4 x 11 cm
 Autoclavable

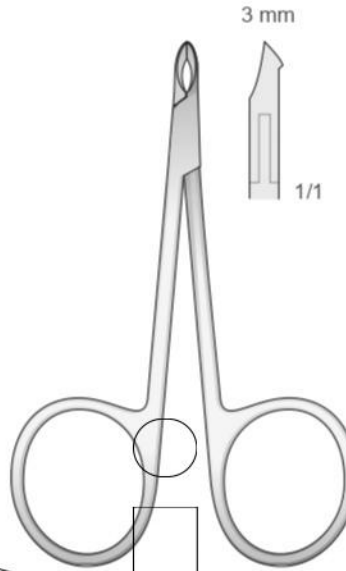

BI-GS-40
 85 mm

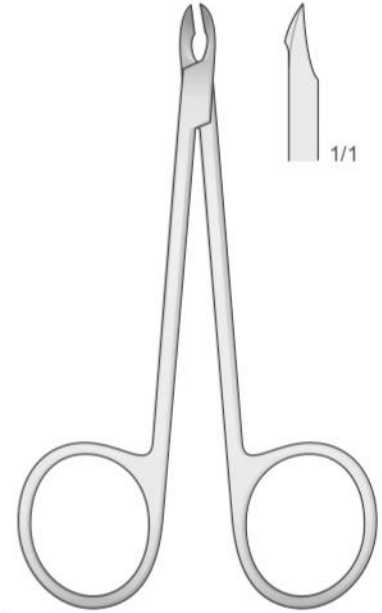

BI-GS-52
 100 mm

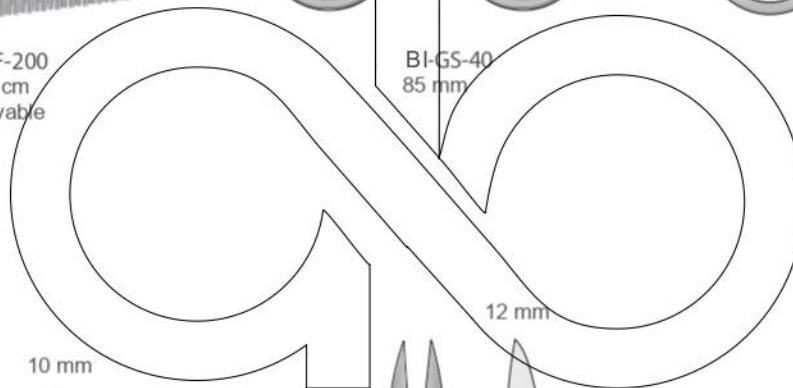

BI-GS-42
 100 mm

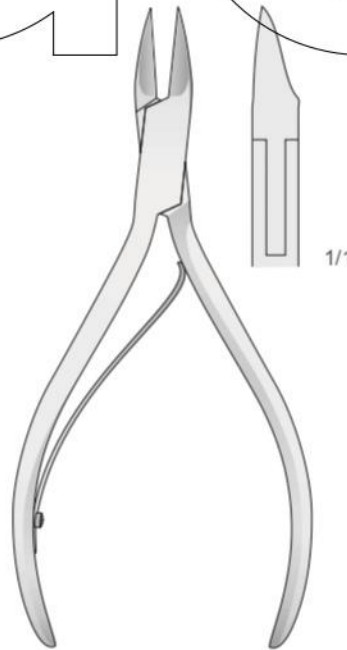

BI-GS-44
 110 mm

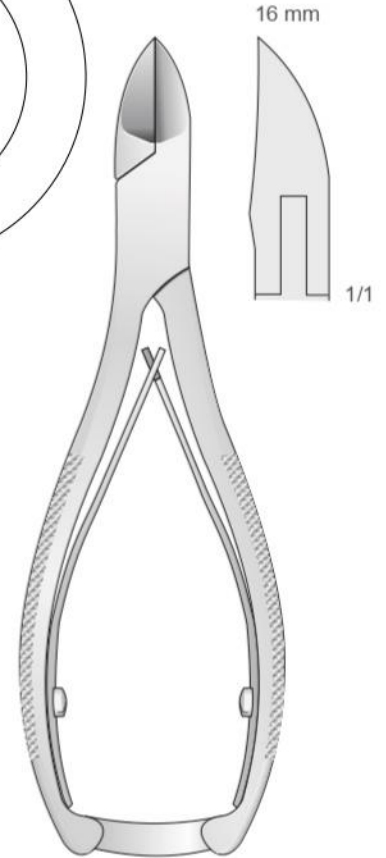

BI-GS-48
 140 mm

Sterilisierzangen
Sterilizing Forceps
Pinze per sterilizzazione
Pinzas para esterilización
Pincas pour stérilisation



BI-GS-02
145 mm



DAVIS
BI-GS-03
160 mm



DAVIS
BI-GS-04
200 mm

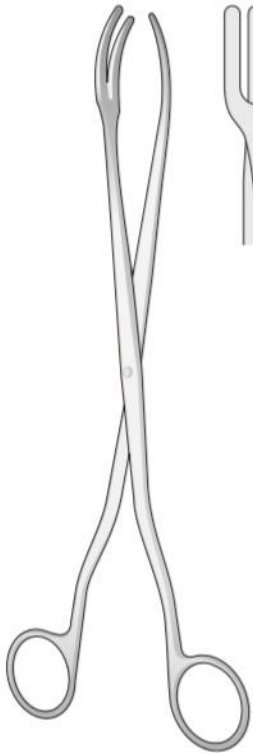
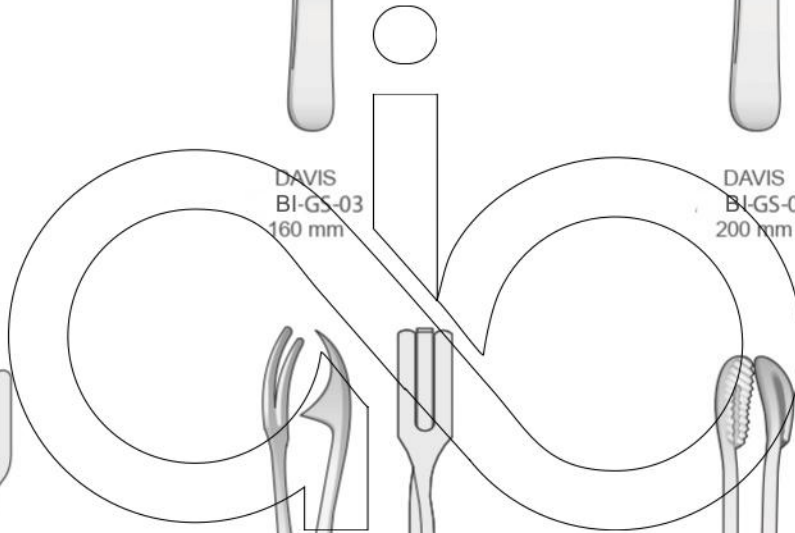

BI-GS-10
200 mm



1/1

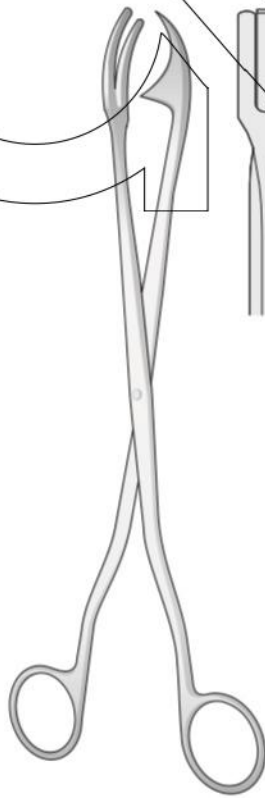

ROGGE
BI-GS-06
230 mm



1/1

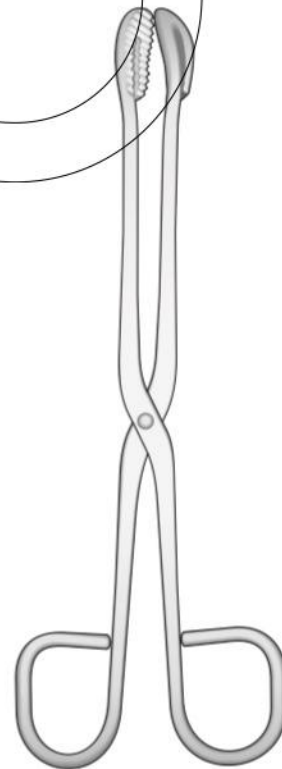

BI-GS-13
200 mm



ALL IN ONE

SUPPLIES

Manufacturer & Exporter Of Surgical, Dental & Orthopedic Instruments.

+92-333-8740-629

info@aiosupplies.com | medisuraj@gmail.com

Bismillah Street, Kacha Shahab Pura, S.I.E. Sialkot Pakistan www.aiosupplies.com



ISO
9001:2008

