



ALL IN ONE
SUPPLIES



CATALOGUE

Needle Holders



Nadelhalter
Needle Holders
Port'aghi
Portaagujas
Porte aiguilles

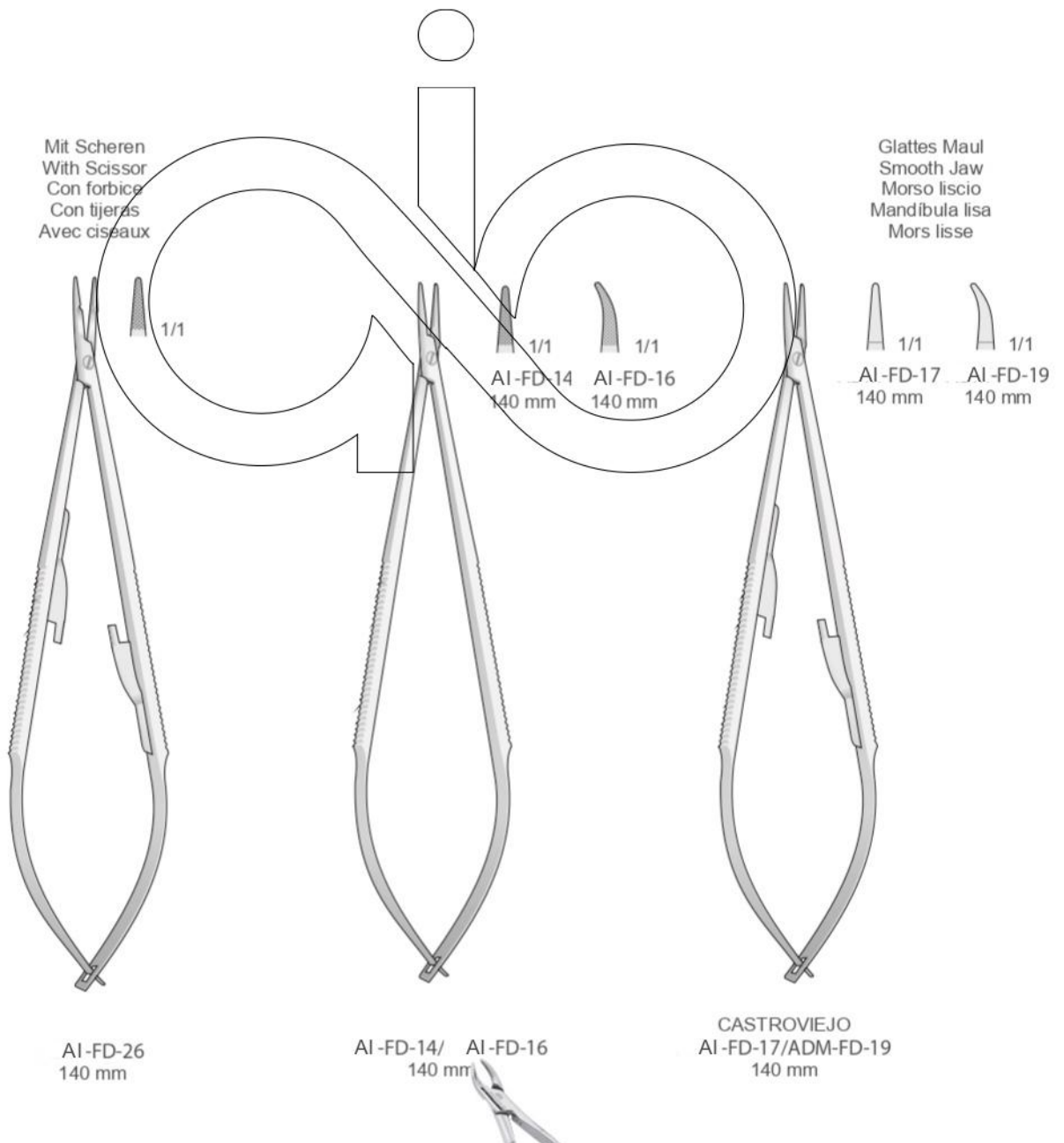

Nadelhalter
Needle Holders
Port'aghi
Portaagujas
Porte aiguilles

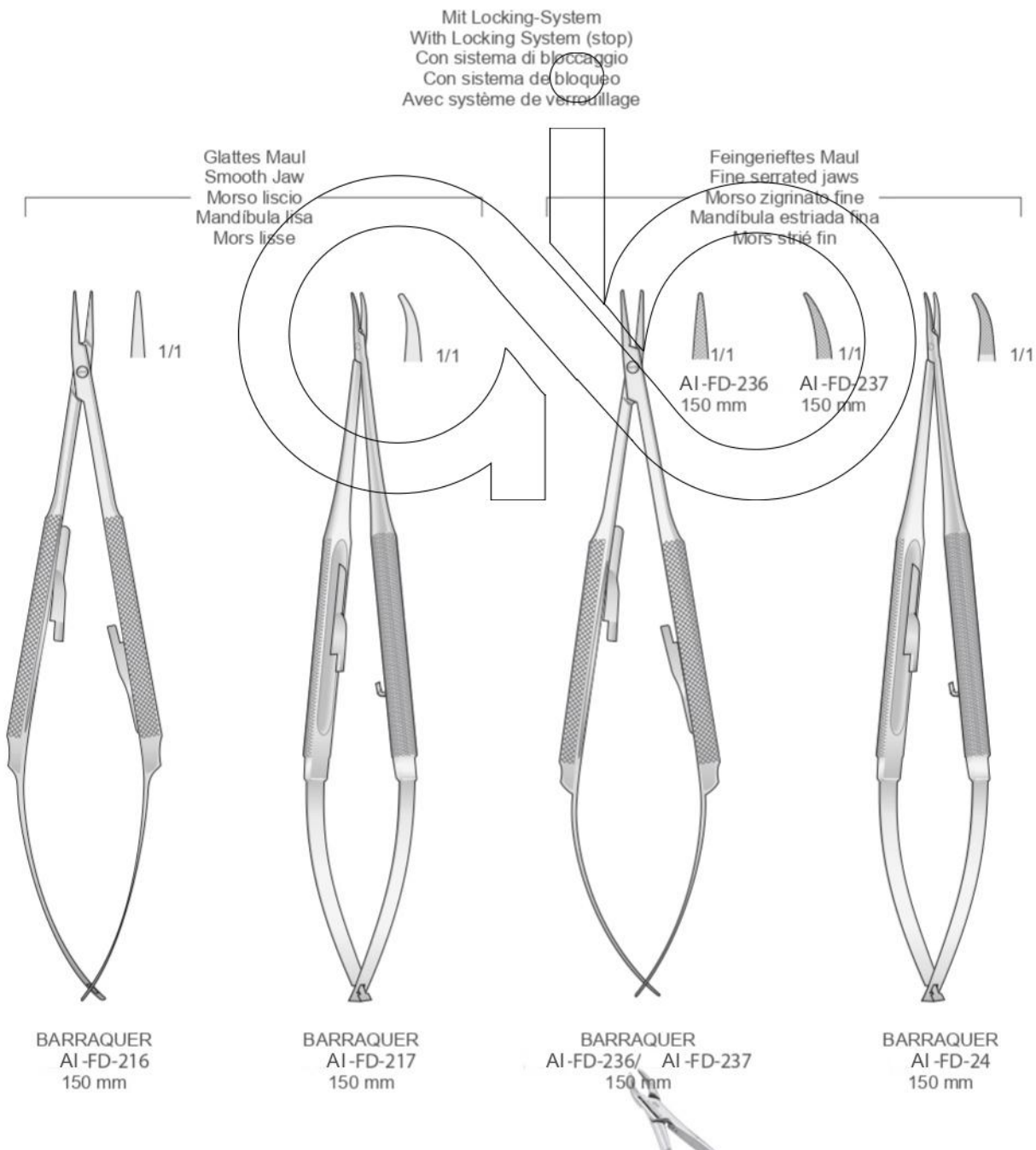



Nadelhalter
Needle Holders
Port'aghi
Portaagujas
Porte aiguilles

Tungsten-Carbide Inserts
Mit Hartmetalleinsätzen
Plaquettes en carbure de tungstène
Plaquetas de carburo de tungsteno
Inserti in carburo di tungsteno

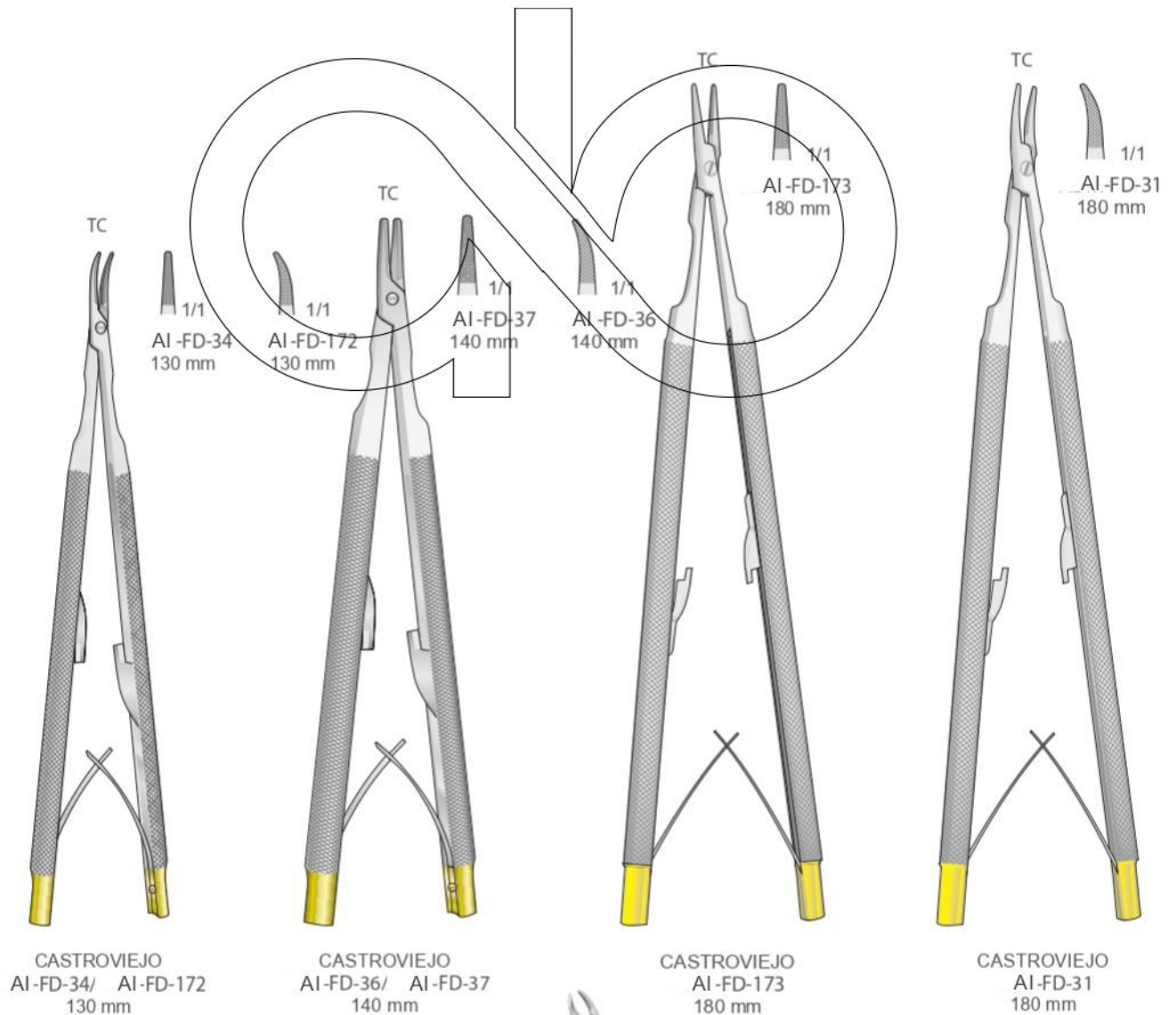

Nadelhalter
Needle Holders
Port'aghi
Portaagujas
Porte aiguilles

Tungsten-Carbide Inserts
Mit Hartmetalleinsätzen
Plaquettes en carbure de tungstène
Plaquetas de carburo de tungsteno
Inserti in carburo di tungsteno

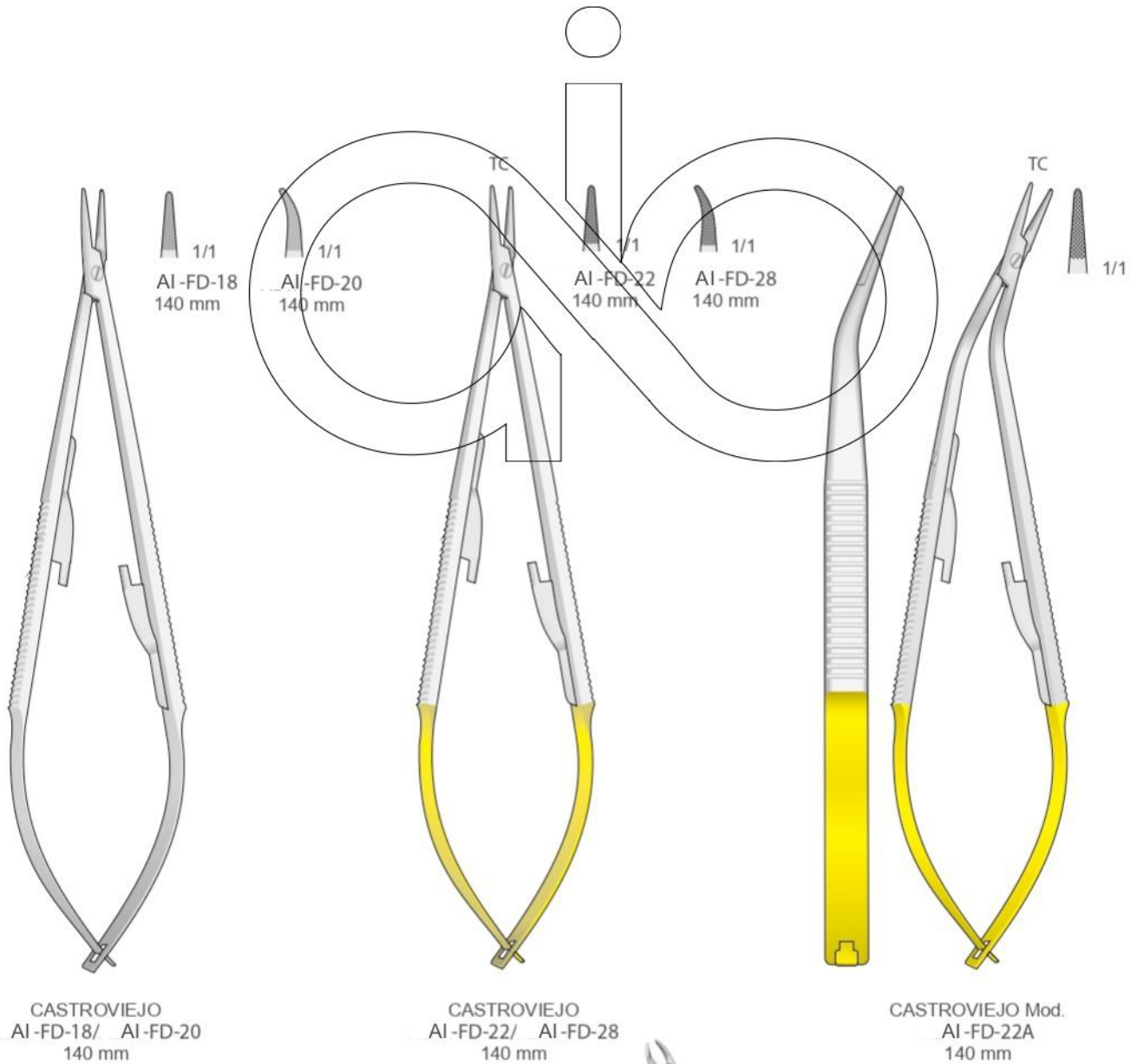



Nadelhalter
Needle Holders
Port'aghi
Portaagujas
Porte aiguilles

Tungsten-Carbide Inserts
Mit Hartmetalleinsätzen
Plaquettes en carbure de tungstène
Plaquetas de carburo de tungsteno
Inserti in carburo di tungsteno

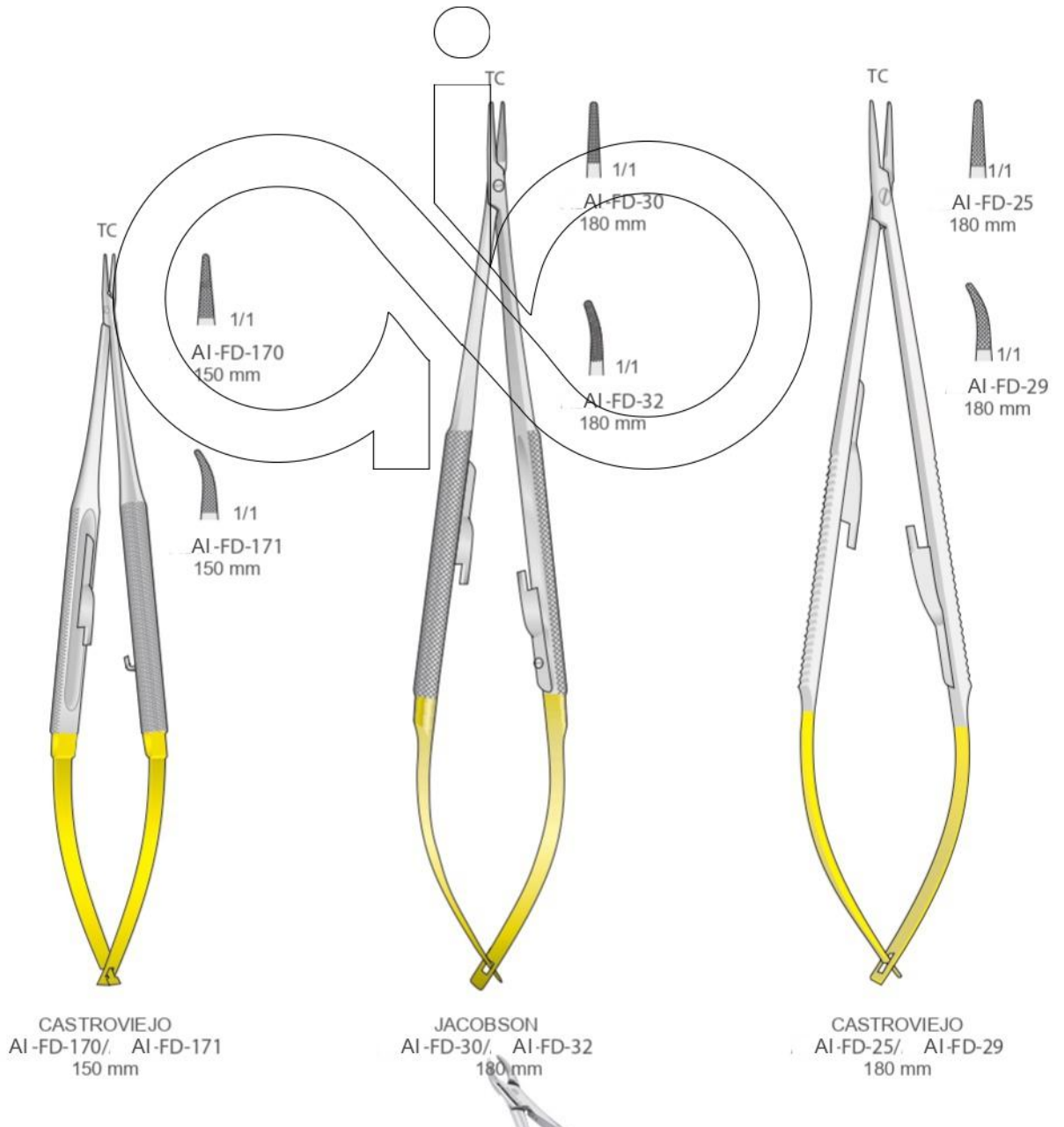

Nadelhalter
Needle Holders
Port'aghi
Portaagujas
Porte aiguilles

Tungsten-Carbide Inserts
Mit Hartmetalleinsätzen
Plaquettes en carbure de tungstène
Plaquetas de carburo de tungsteno
Inserti in carburo di tungsteno

Diamond Tip
Diamantiert
Punta diamantata
Punta de diamante
Pointe de diamant

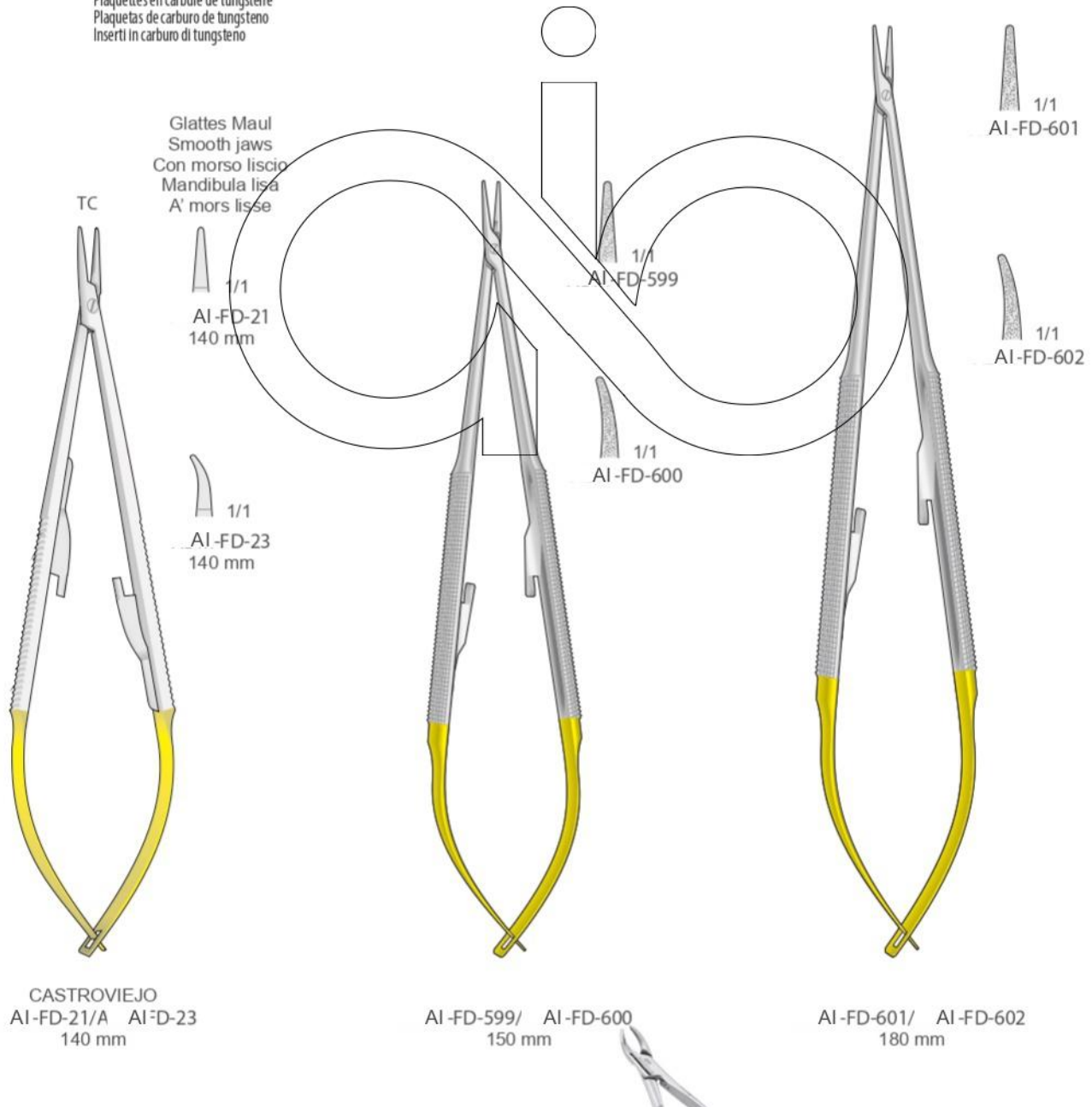

Mikro Nadelhalter - Mikro Scheren
 Micro Needle Holders - Micro Scissors
 Micro Port'aghi - Micro Forbici
 Micro Portaagujas - Micro Tijeras
 Micro Porte aiguilles - Micro Ciseaux

Titanium
 Titan
 Titane
 Titanio
 Titanio

Rund-Griffe Ø 8 mm
 Round handle Ø 8 mm
 Manico rotondo Ø 8 mm
 Mango redondo Ø 8 mm
 Manche rond Ø 8 mm

Mikro Nadelhalter
 Micro Needle Holders
 Micro port'aghi
 Micro portaagujas
 Micro porte aiguilles

Mikro Scheren
 Micro Scissors
 Micro forbici
 Micro tijeras
 Micro ciseaux

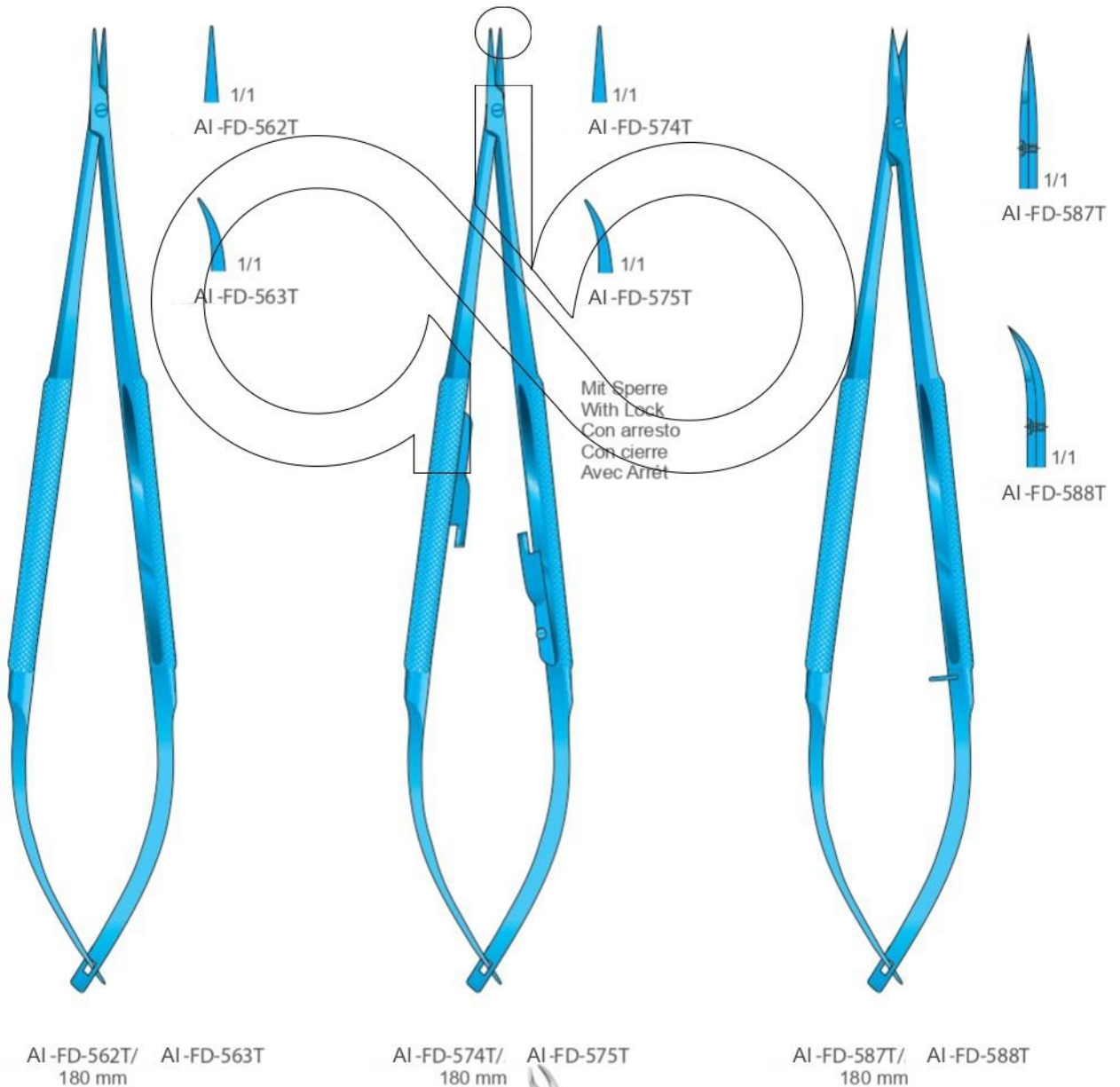

Nadelhalter
Needle Holders
Port'aghi
Portaagujas
Porte aiguilles

Tungsten-Carbide Inserts
Mit Hartmetalleinsätzen
Plaquettes en carbure de tungstène
Plaquetas de carburo de tungsteno
Inserti in carburo di tungsteno

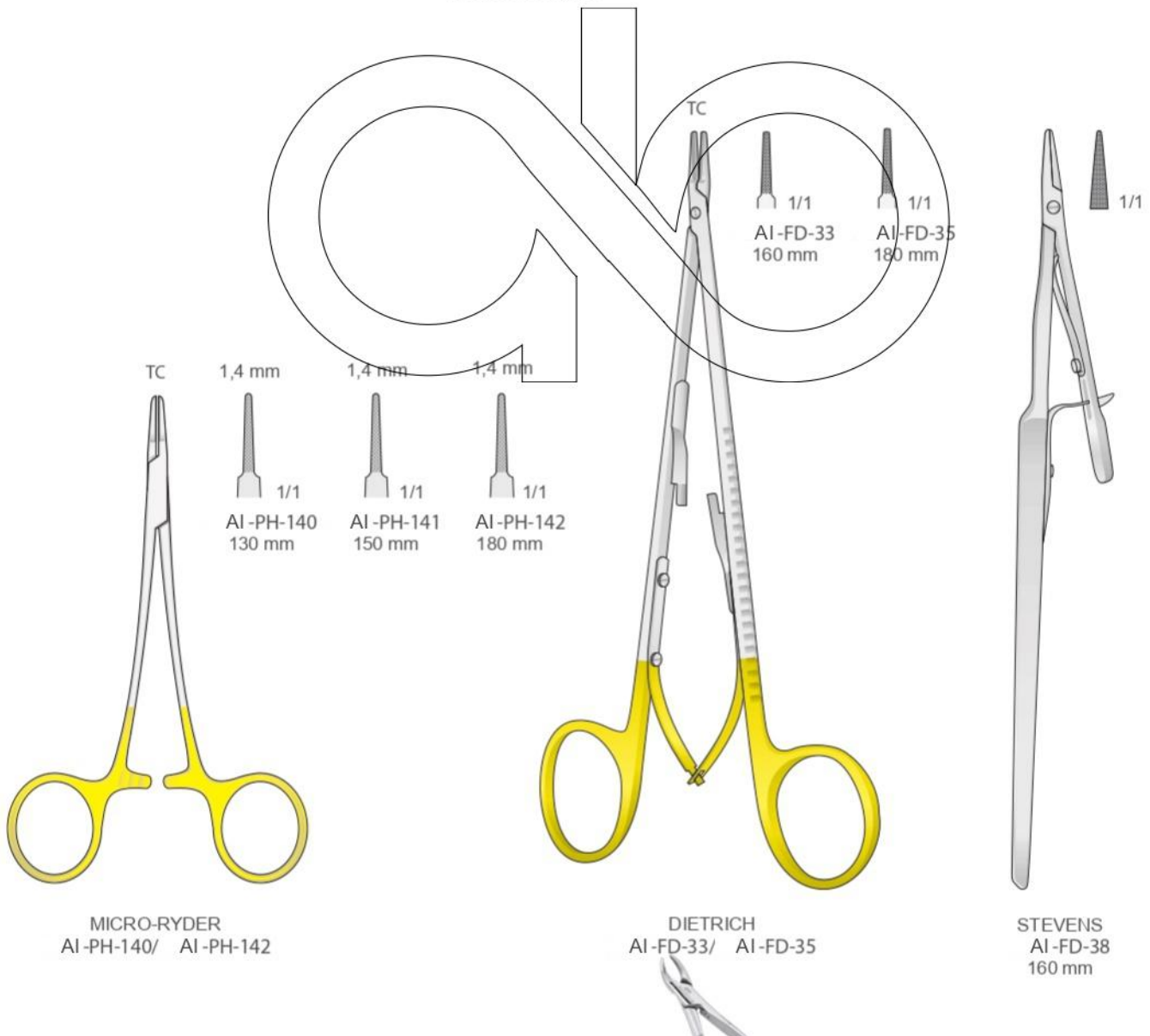



Nadelhalter
Needle Holders
Port'aghi
Portaagujas
Porte aiguilles

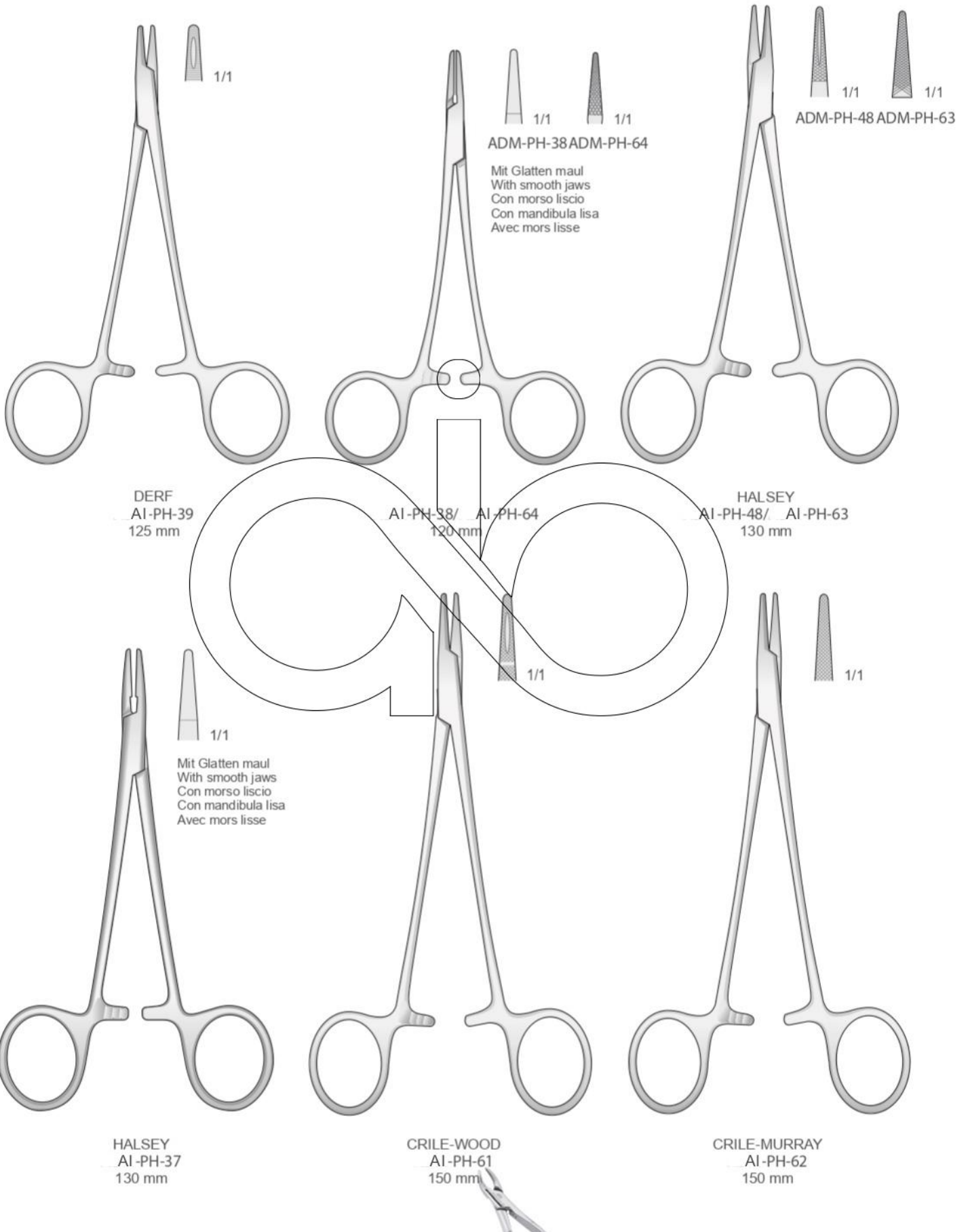

Nadelhalter mit Schere - Needle holders with scissors
Port'aghi con forbici - Portaagujas con tijeras
Porte aiguilles avec ciseaux

Nadelhalter
Needle Holders
Port'aghi
Portaagujas
Porte aiguilles

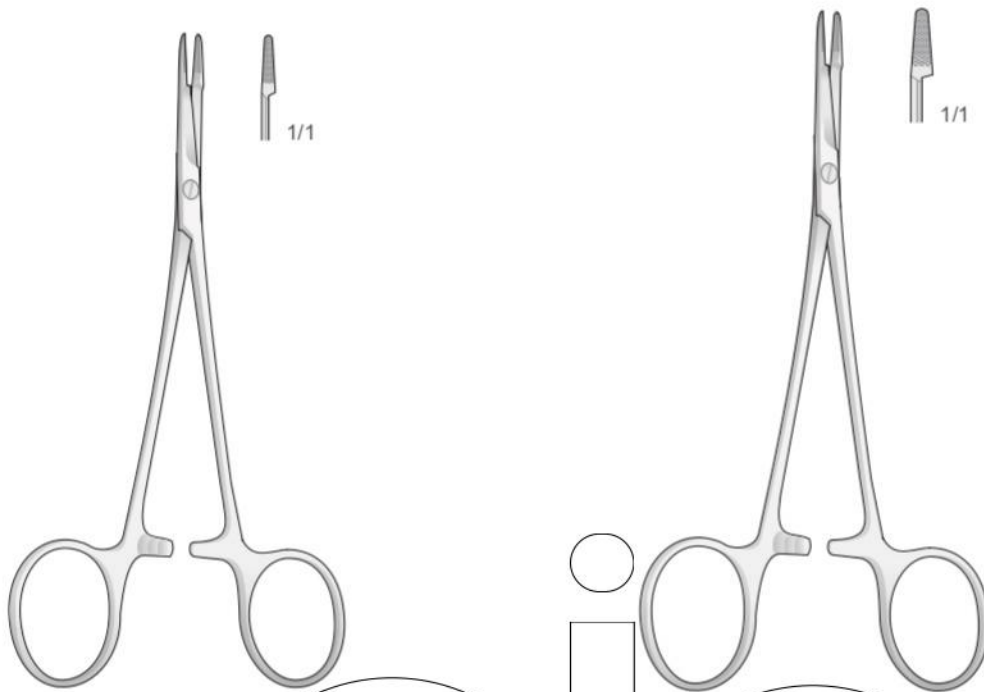

MINI-OLSEN-HEGAR
AI-BM-61
120 mm

OLSEN-HEGAR
AI-BM-62
140 mm

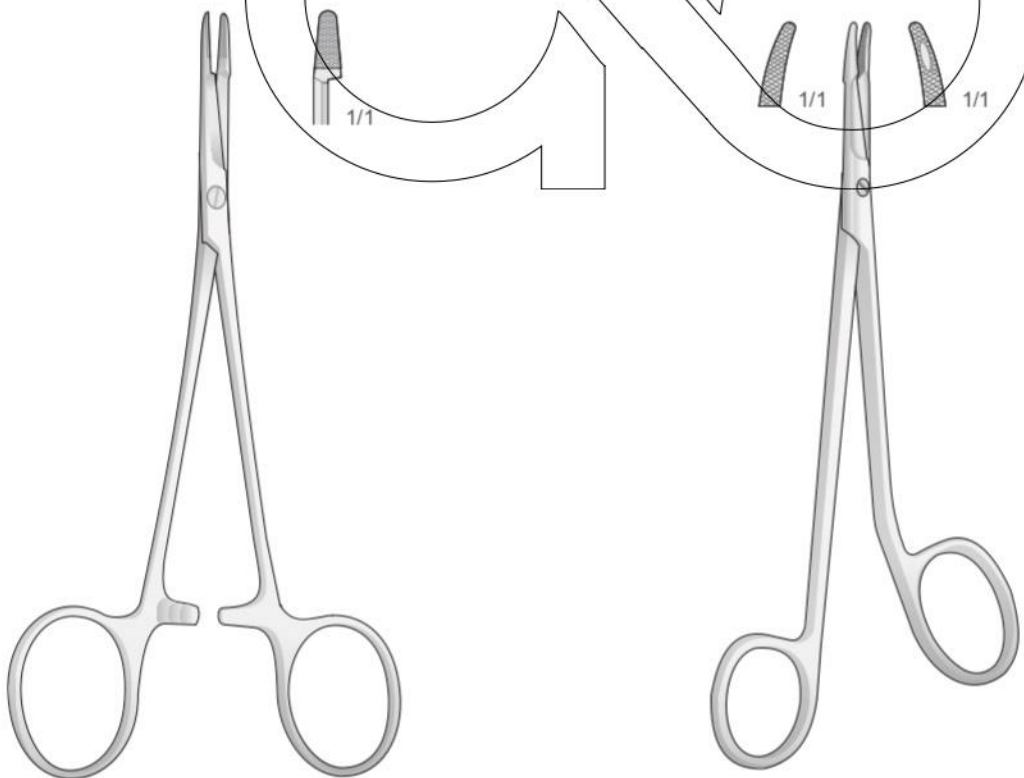

OLSEN-HEGAR
AI-BM-63
170 mm

MINI-GILLIES
AI-PO-59
145 mm



Nadelhalter
Needle Holders
Port'aghi
Portaagujas
Porte aiguilles

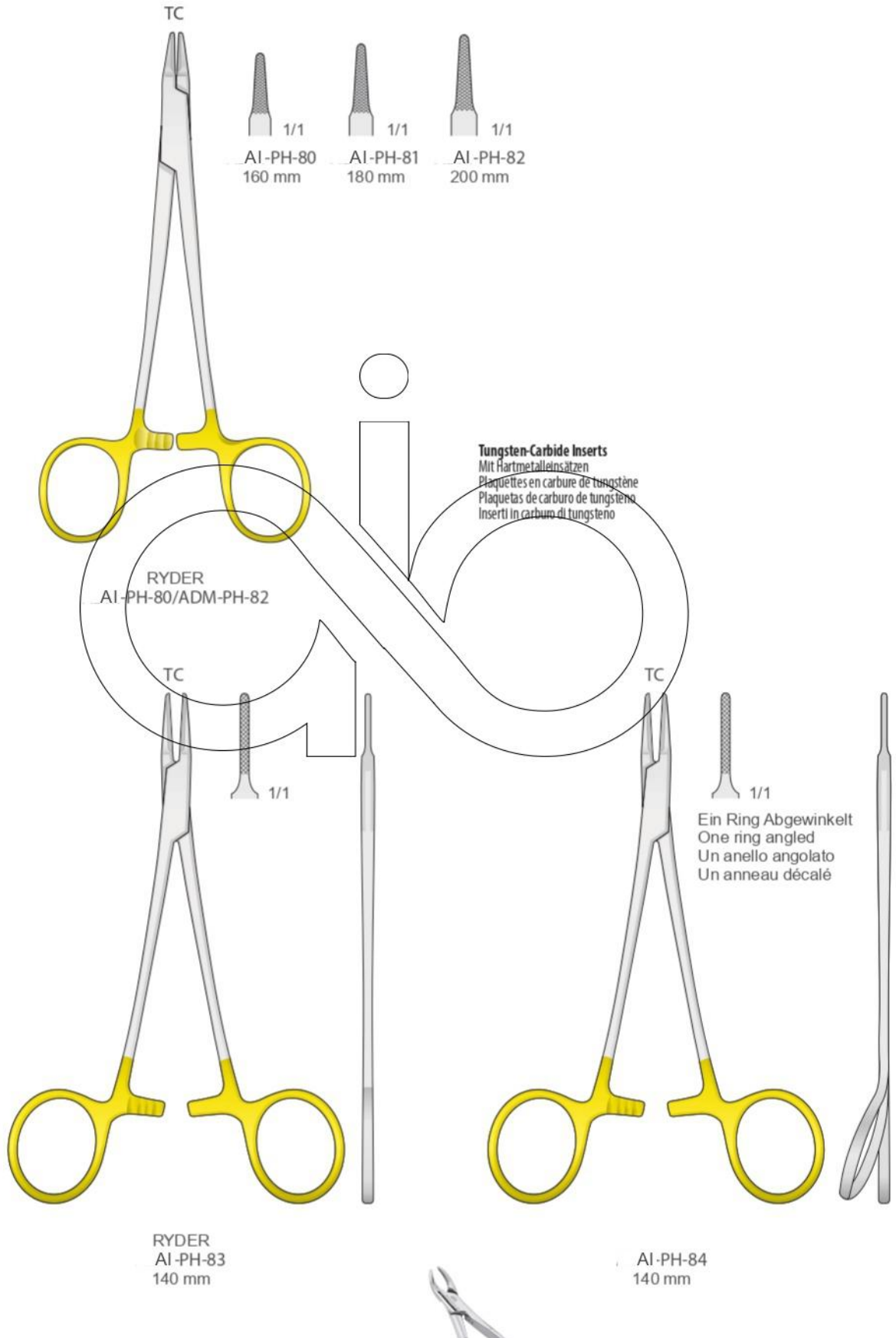

Nadelhalter
Needle Holders
Port'aghi
Portaagujas
Porte aiguilles

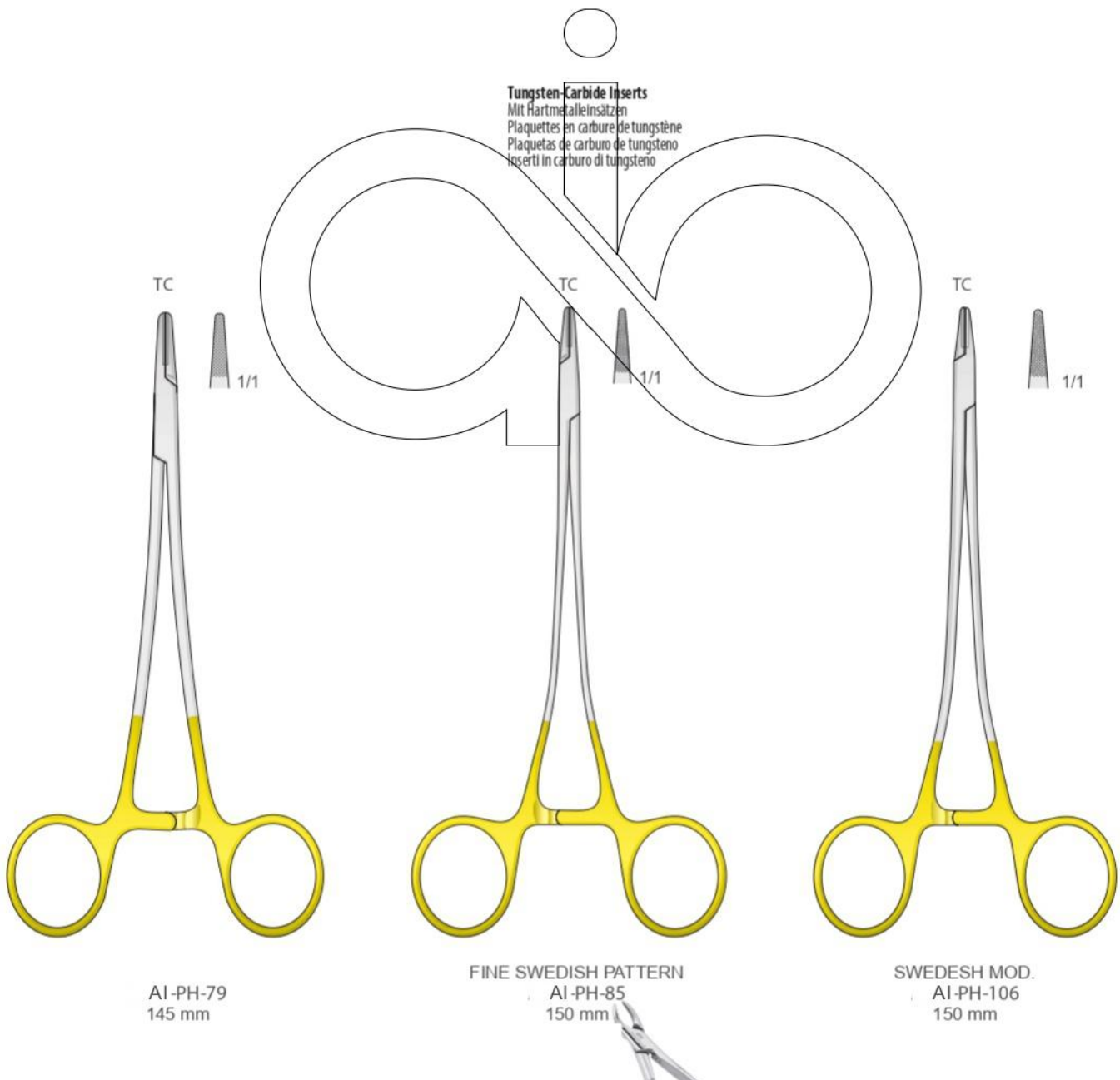



Nadelhalter
Needle Holders
Port'aghi
Portaagujas
Porte aiguilles

Tungsten-Carbide Inserts
Mit Hartmetalleinsätzen
Plaquettes en carbure de tungstène
Plaquetas de carburo de tungsteno
Inserti in carburo di tungsteno

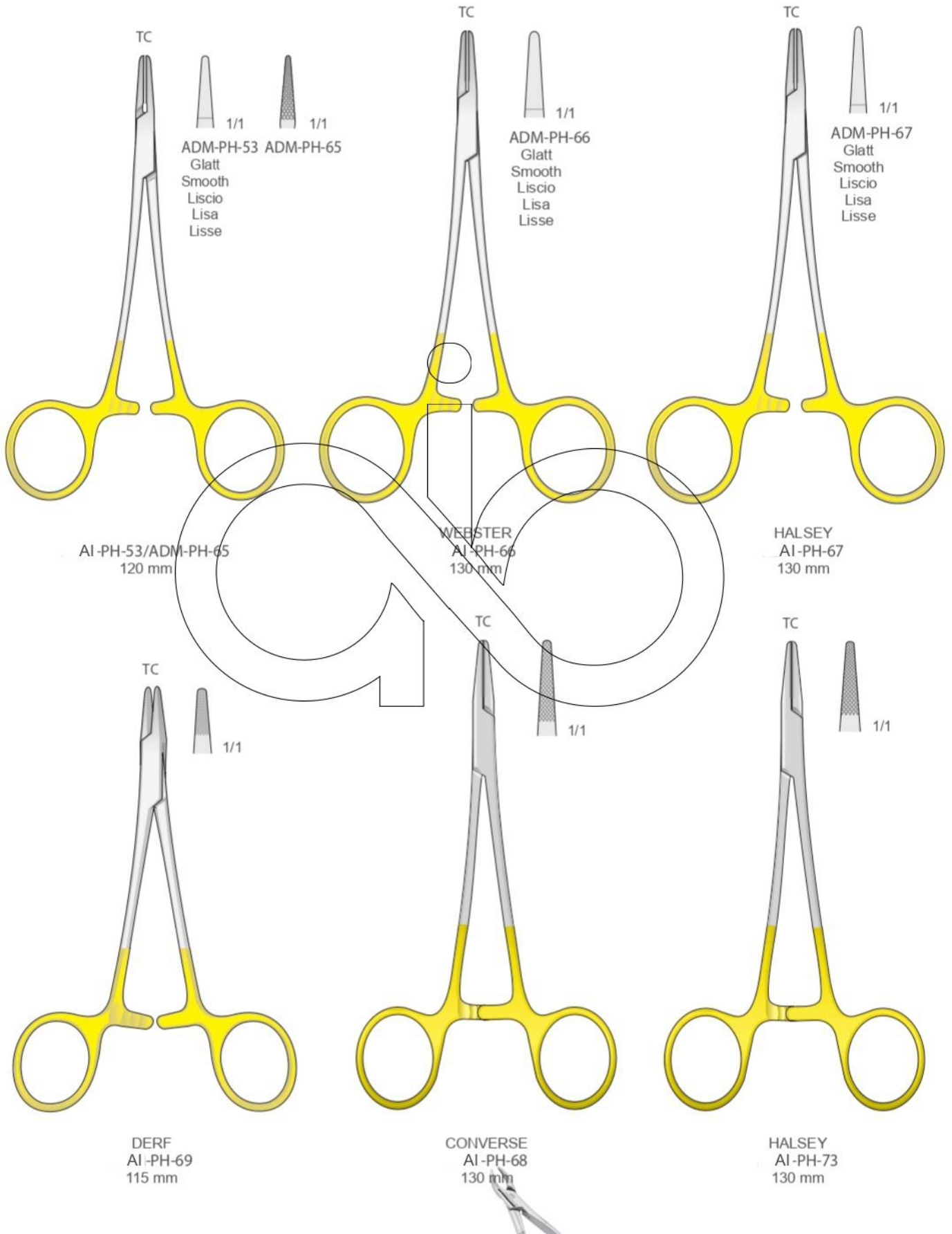

Tungsten-Carbide Inserts
 Mit Hartmetalleinsätzen
 Plaquettes en carbure de tungstène
 Plaquetas de carburo de tungsteno
 Inserti in carburo di tungsteno

Nadelhalter
 Needle Holders
 Port'aghi
 Portaagujas
 Porte aiguilles

DE BAKEY
 AI-PH-110/ AI-PH-111

MICRO-VASCULAR
 AI-PH-101/ AI-PH-102/ AI-PH-103

MAYO-HEGAR
 AI-PH-120/ AI-PH-121/ AI-PH-122

MAYO-HEGAR-FINO
 AI-PH-127/ AI-PH-128/ AI-PH-129

Insert Diagrams:

- AI-PH-110: 150 mm, 1/1
- AI-PH-111: 180 mm, 1/1
- AI-PH-101: 150 mm, 1/1
- AI-PH-102: 180 mm, 1/1
- AI-PH-103: 200 mm, 1/1
- AI-PH-120: 140 mm, 1/1
- AI-PH-121: 160 mm, 1/1
- AI-PH-122: 190 mm, 1/1
- AI-PH-127: 150 mm, 1/1
- AI-PH-128: 180 mm, 1/1
- AI-PH-129: 205 mm, 1/1

Classification:
 Vascular
 Vaskuläre
 Vasculaire
 Vasculares
 Vascolari



Nadelhalter
Needle Holders
Port'aghi
Portaagujas
Porte aiguilles

Tungsten-Carbide Inserts
Mit Hartmetalleinsätzen
Plaquettes en carbure de tungstène
Plaquetas de carburo de tungsteno
Inserti in carburo di tungsteno

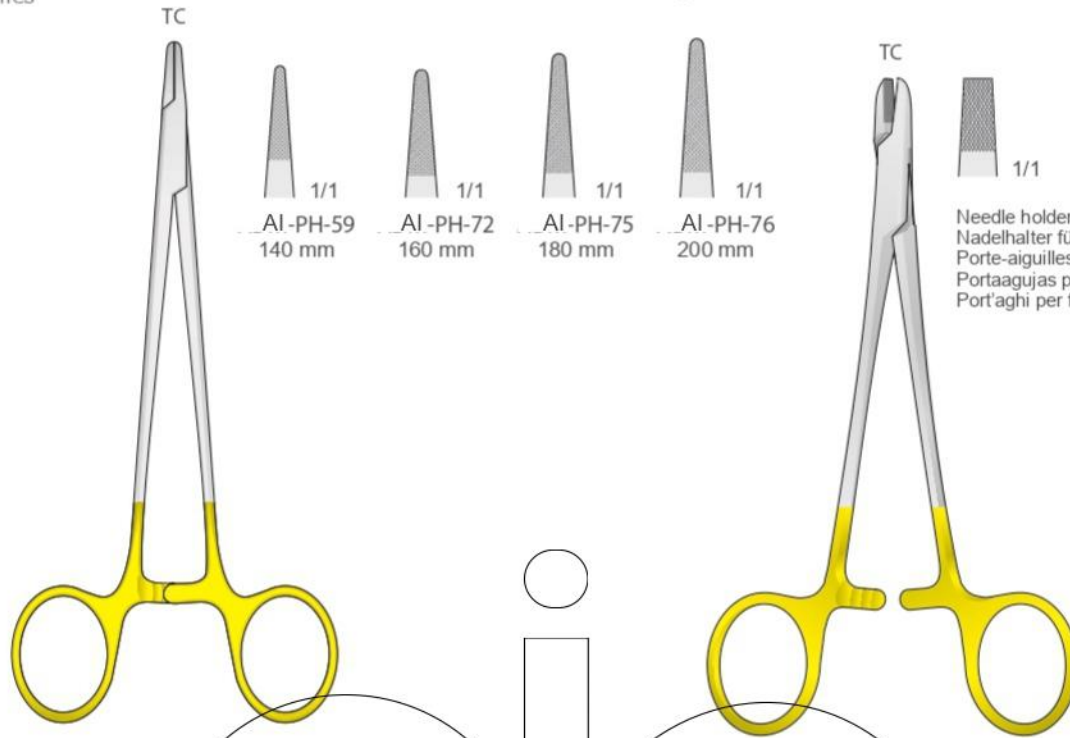

Needle holders for wire
Nadelhalter für drähte
Porte-aiguilles pour fil métallique
Portaagujas para hilo metálico
Port'aghi per fili metallici

HEGAR
AI-PH-59/ AI-PH-72/ AI-PH-75/ AI-PH-76

AI-PH-58
150 mm

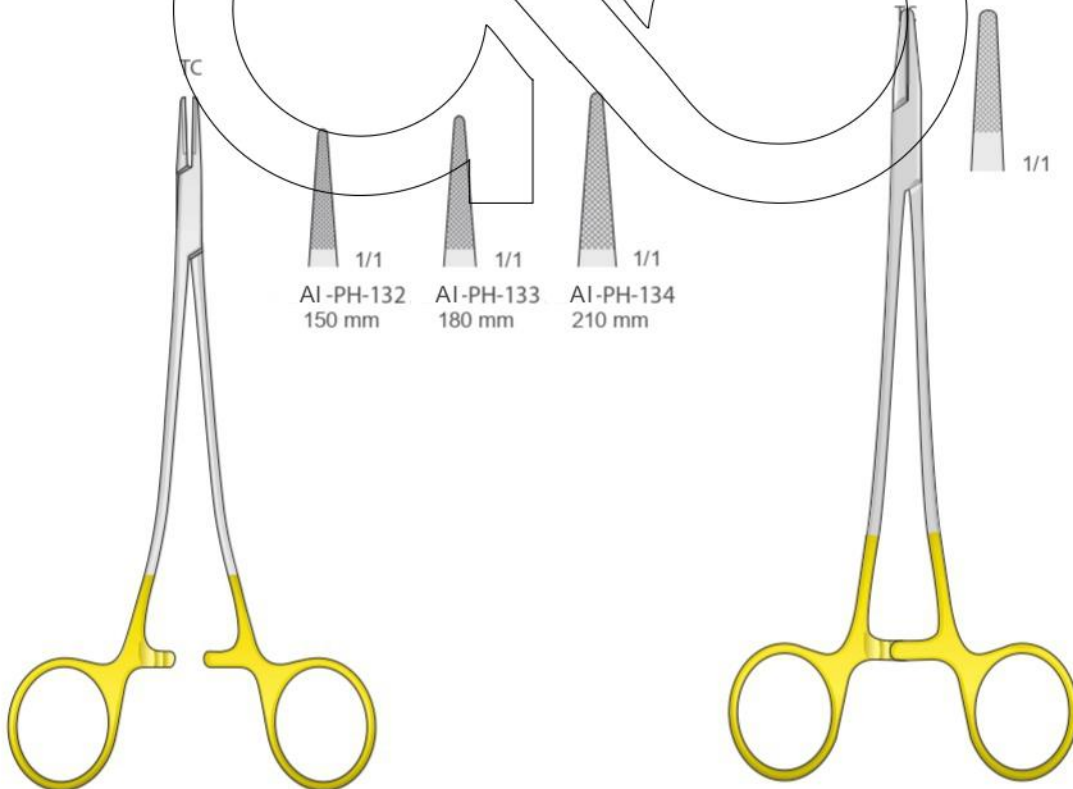

SAROT
AI-PH-132/ AI-PH-133/ AI-PH-134

CRILE-WOOD
AI-PH-77
180 mm

Tungsten-Carbide Inserts
 Mit Hartmetalleinsätzen
 Plaquettes en carbure de tungstène
 Plaquetas de carburo de tungsteno
 Inserti in carburo di tungsteno

Nadelhalter
 Needle Holders
 Port'aghi
 Portaagujas
 Porte aiguilles

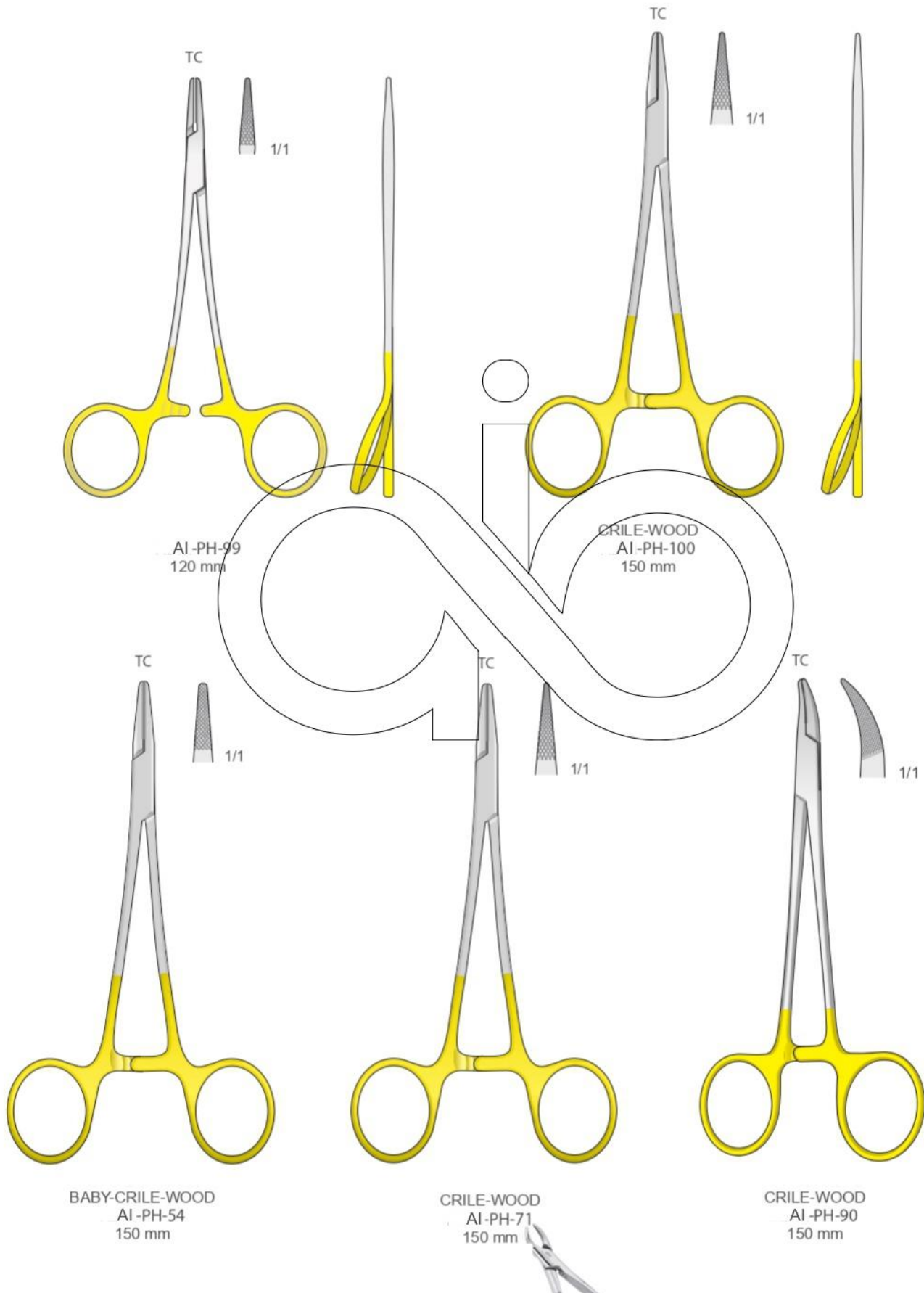

Nadelhalter
Needle Holders
Port'aghi
Portaagujas
Porte aiguilles

Tungsten-Carbide Inserts
Mit Hartmetalleinsätzen
Plaquettes en carbure de tungstène
Plaquetas de carburo de tungsteno
Inserti in carburo di tungsteno

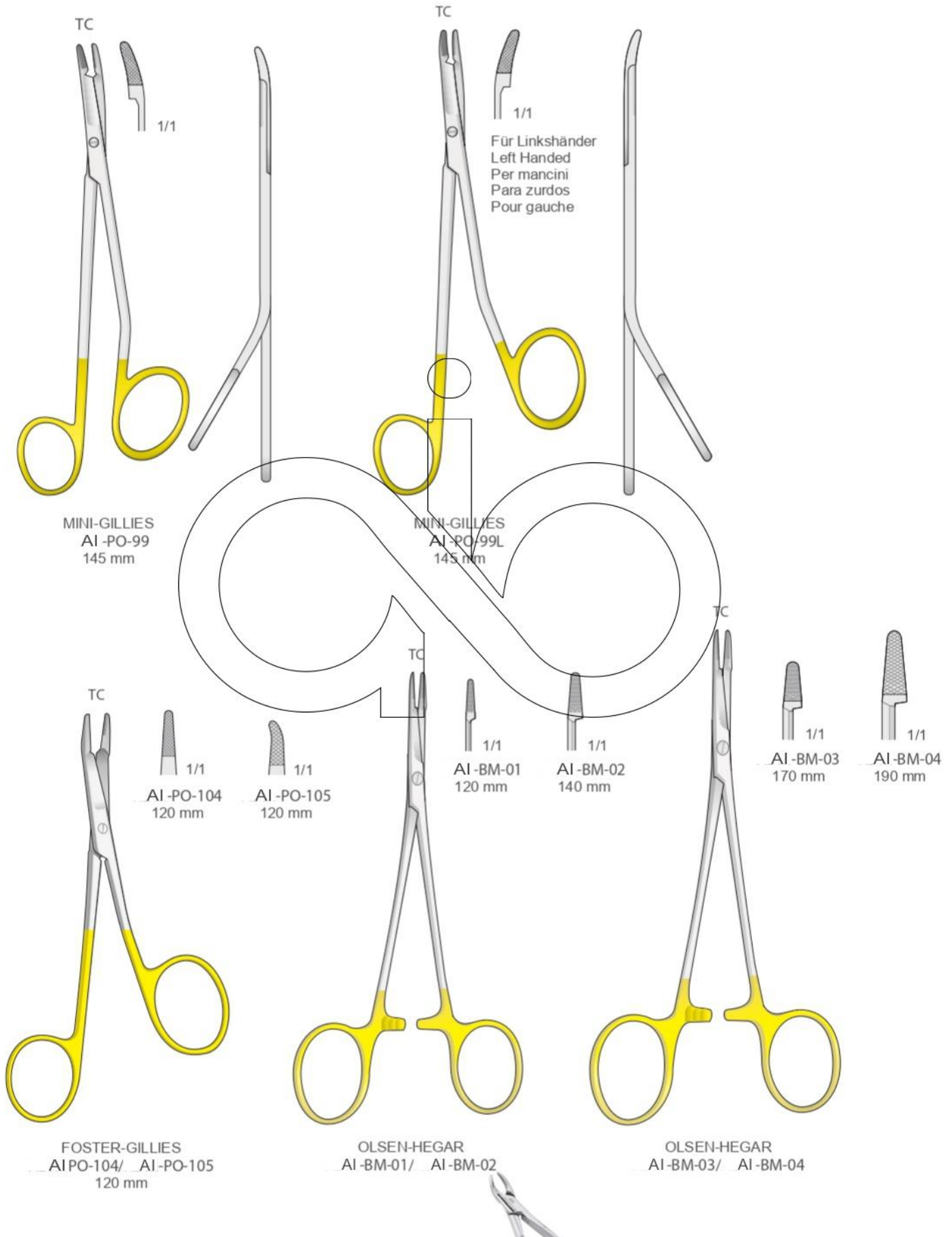

Nadelhalter
Needle Holders
Port'aghi
Portaagujas
Porte aiguilles

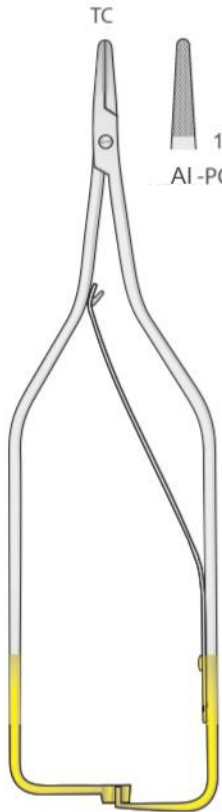

ARRUGA
AI-PO-85/ AI-PO-87
160 mm

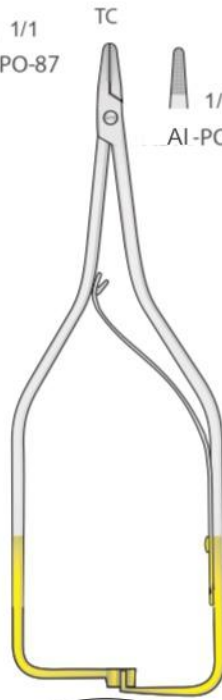
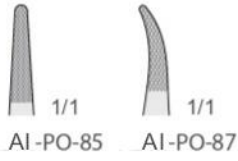

BOYNTON
AI-PO-55/ AI-PO-56
120 mm

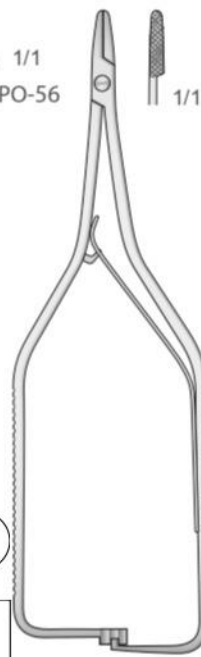

BOYNTON
AI-PO-88
120 mm

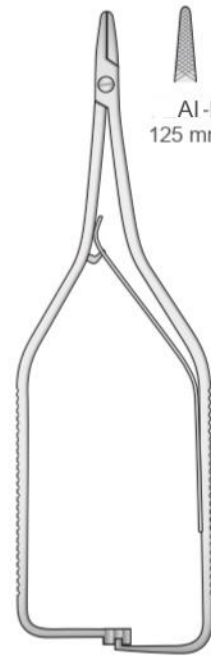

BOYNTON
AI-PO-94
125 mm



MATHIEU
AI-PO-50/ AI-PO-52

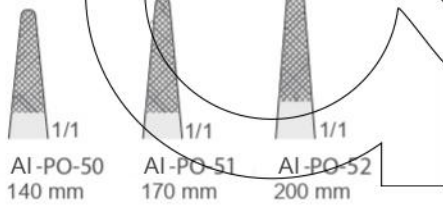

MATHIEU
AI-PO-82/ AI-PO-84

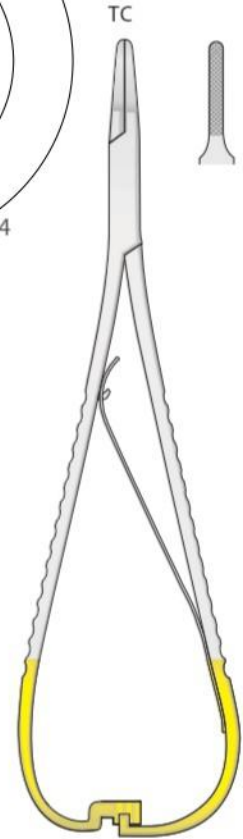
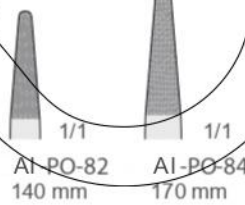

LICHTENBERG
AI-PO-86
175 mm





Nadelhalter
Needle Holders
Port'aghi
Portaagujas
Porte aiguilles



CRILE
AI-PO-37
150 mm



TONNIS
AI-PO-38
190 mm

Schlankesmodell - Delicate pattern - Modello fine
Modelo delegado - Modèle fin

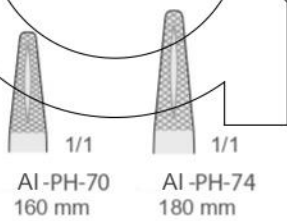

AI-PH-70
160 mm

AI-PH-74
180 mm

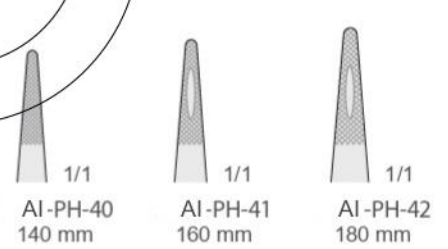

AI-PH-40
140 mm

AI-PH-41
160 mm

AI-PH-42
180 mm

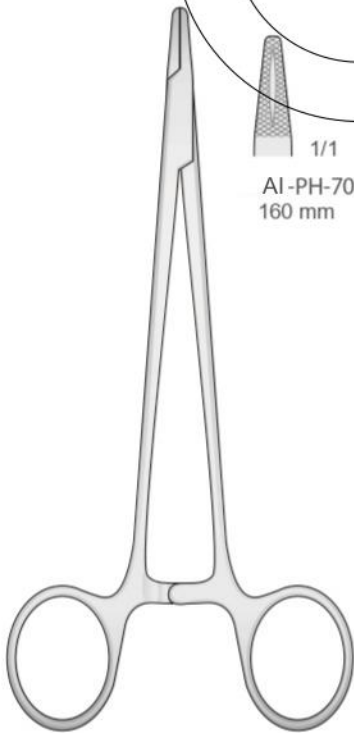

HEGAR
AI-PH-70/ AI-PH-74

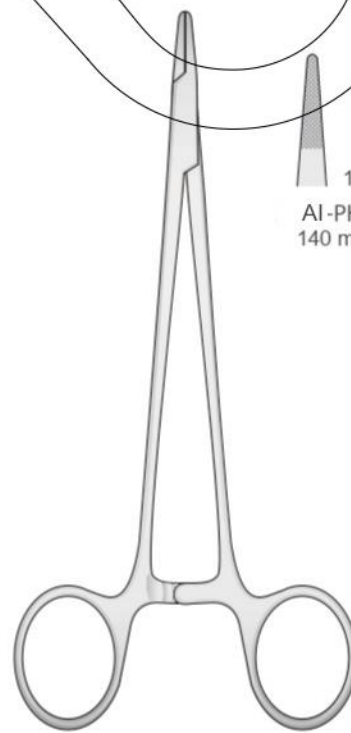

MAYO-HEGAR
AI-PH-40/ AI-PH-42

Nadelhalter
Needle Holders
Port'aghi
Portaagujas
Porte aiguilles



MATHIEU
AI-PO-65/ AI-PO-81

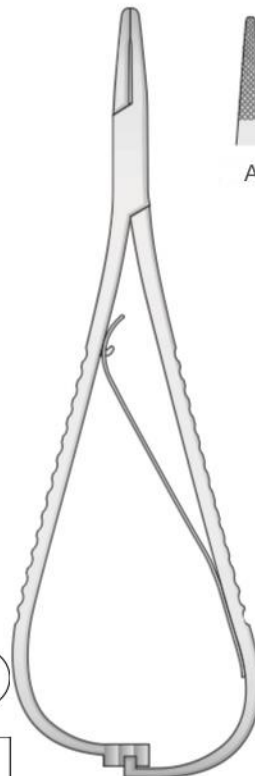
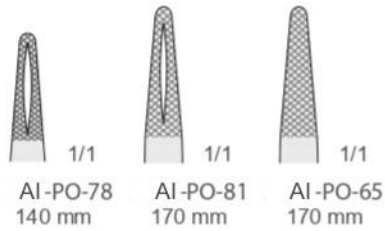

MATHIEU
AI-PO-79/ AI-PO-80
140 mm

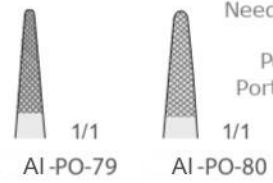

MATHIEU
AI-PO-46/ AI-PO-48

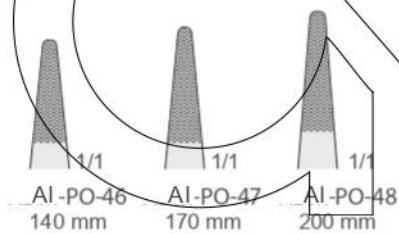

AI-PO-40
140 mm





Nadelhalter
Needle Holders
Port'aghi
Portaagujas
Porte aiguilles

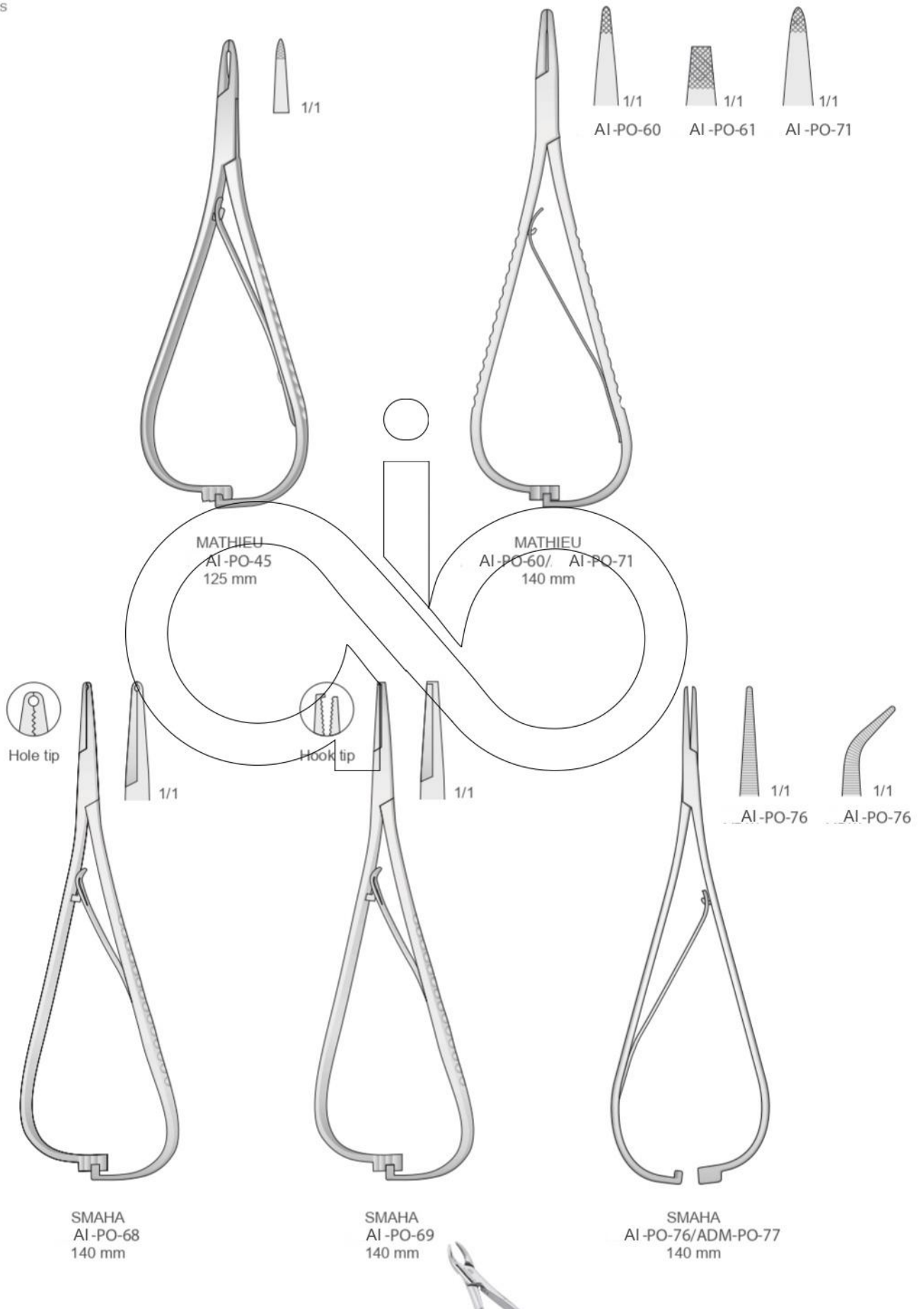



ALL IN ONE

SUPPLIES

Manufacturer & Exporter Of Surgical, Dental & Orthopedic Instruments.

+92-333-8740-629

info@aiosupplies.com | medisuraj@gmail.com

Bismillah Street, Kacha Shahab Pura, S.I.E. Sialkot Pakistan www.aiosupplies.com



ISO
9001:2008

