

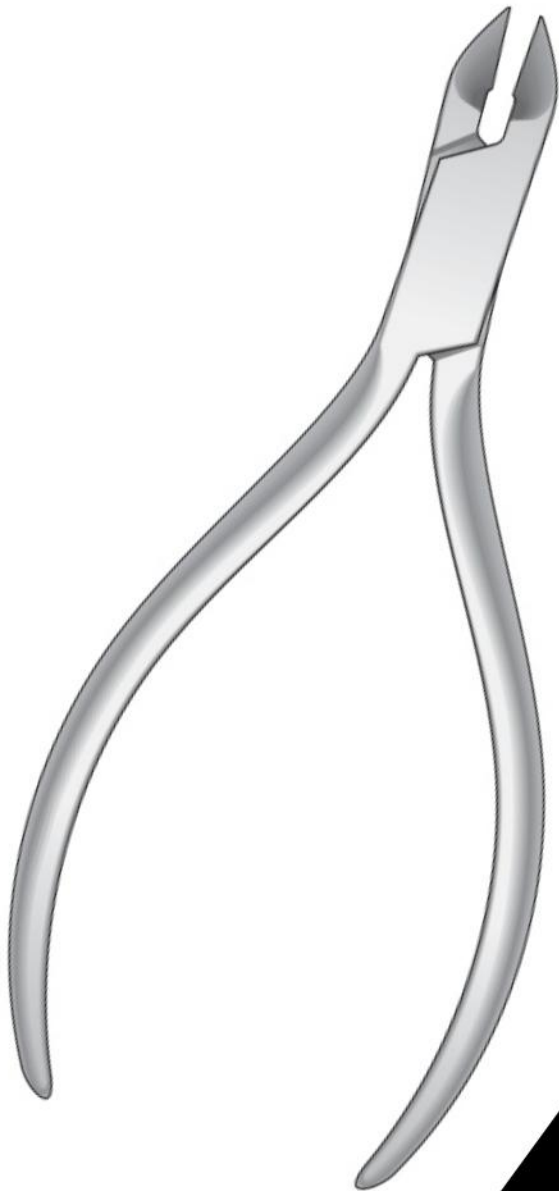

ALL IN ONE
SUPPLIES



CATALOGUE

Orthodontics

Drahtbiegezaugen
Wire Bending Pliers
Pinze per piegare fili
Alicates para doblar alambres
Pincers à plier les fils

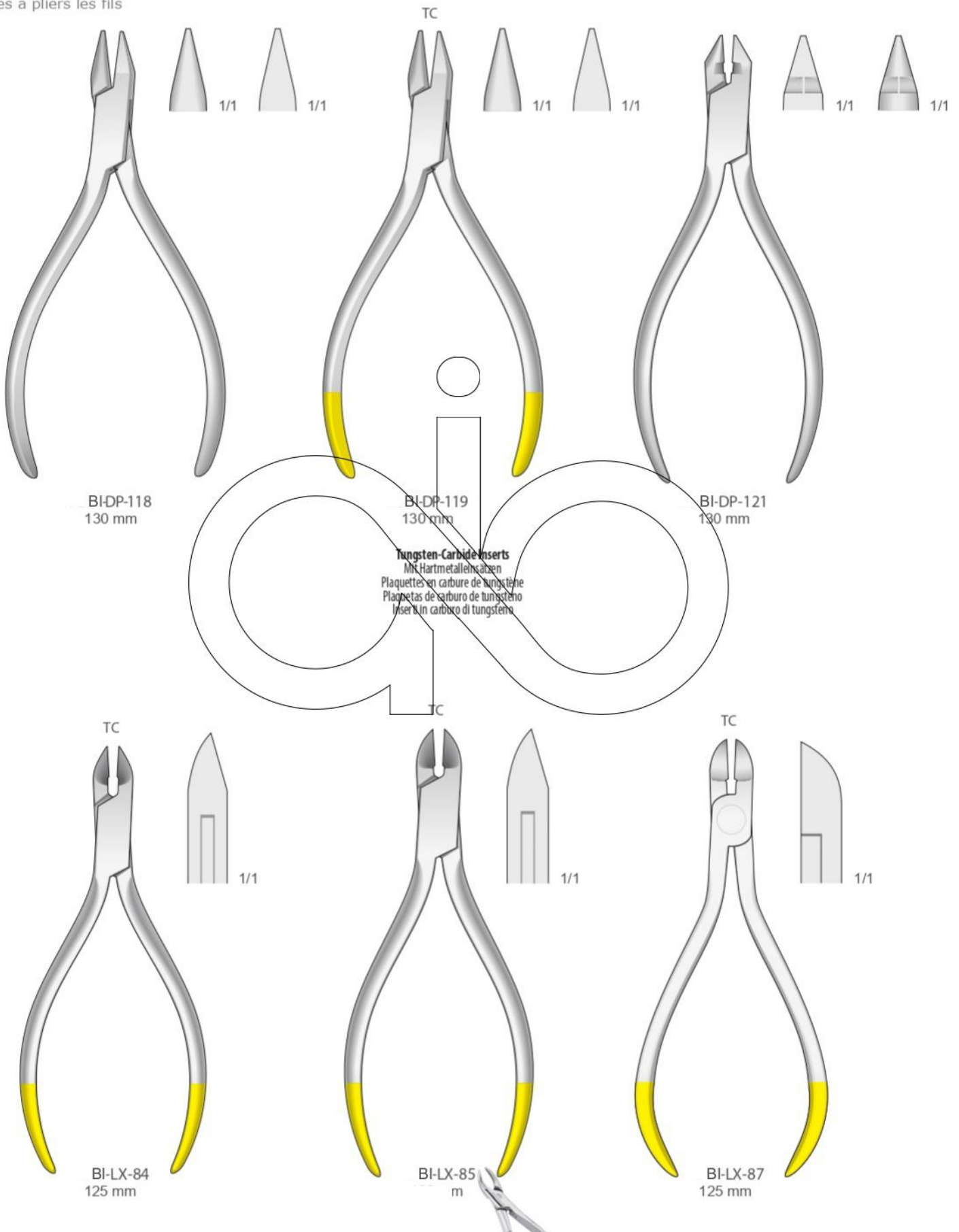

Drahtbiegezaugen
Wire Bending Pliers
Pinze per piegare fili
Alicates para doblar alambres
Pincès à pliers les fils

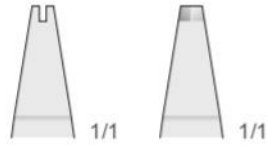

Drahtbiegezaugen
Wire Bending Pliers
Pinze per piegare fili
Alicates para doblar alambres
Pincès à pliers les fils

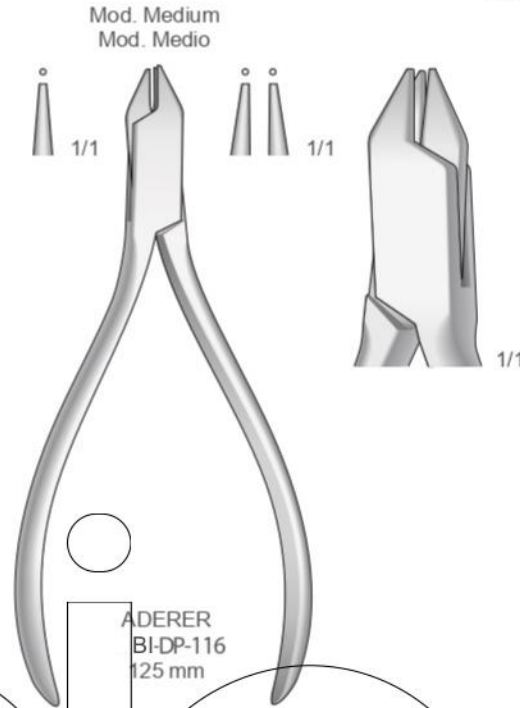

Tungsten-Carbide Inserts
Mit Hartmetalleinsätzen
Plaquettes en carbure de tungstène
Plaquetas de carburo de tungsteno
Inserti in carburo di tungsteno

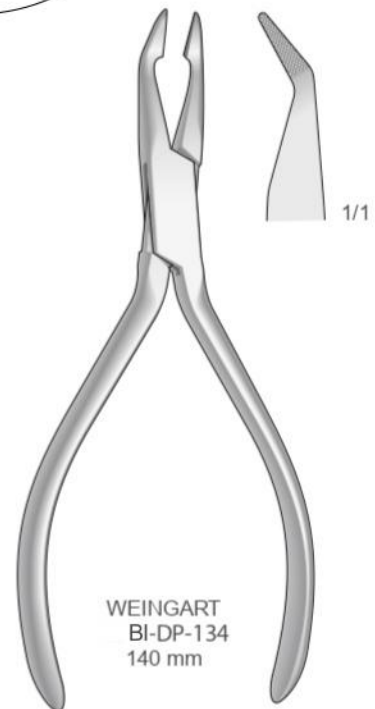
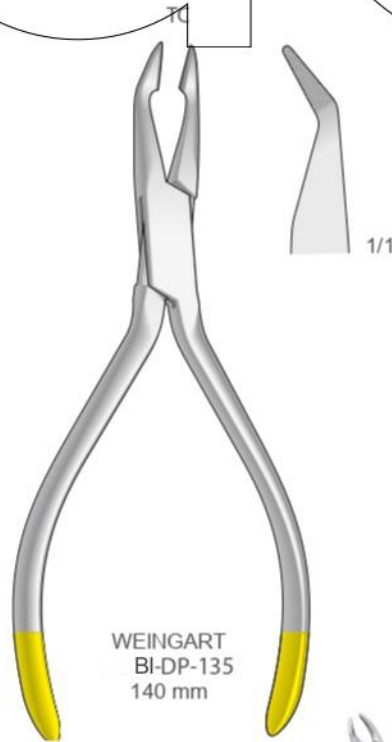
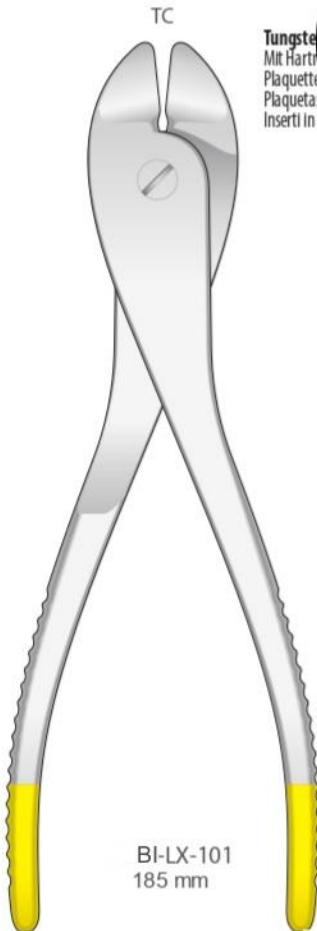

Drahtschneidezangen
Wire cutting pliers
Tronchesi per fili metallici
Alicates para cortar alambre
Pinces à couper les fils TC

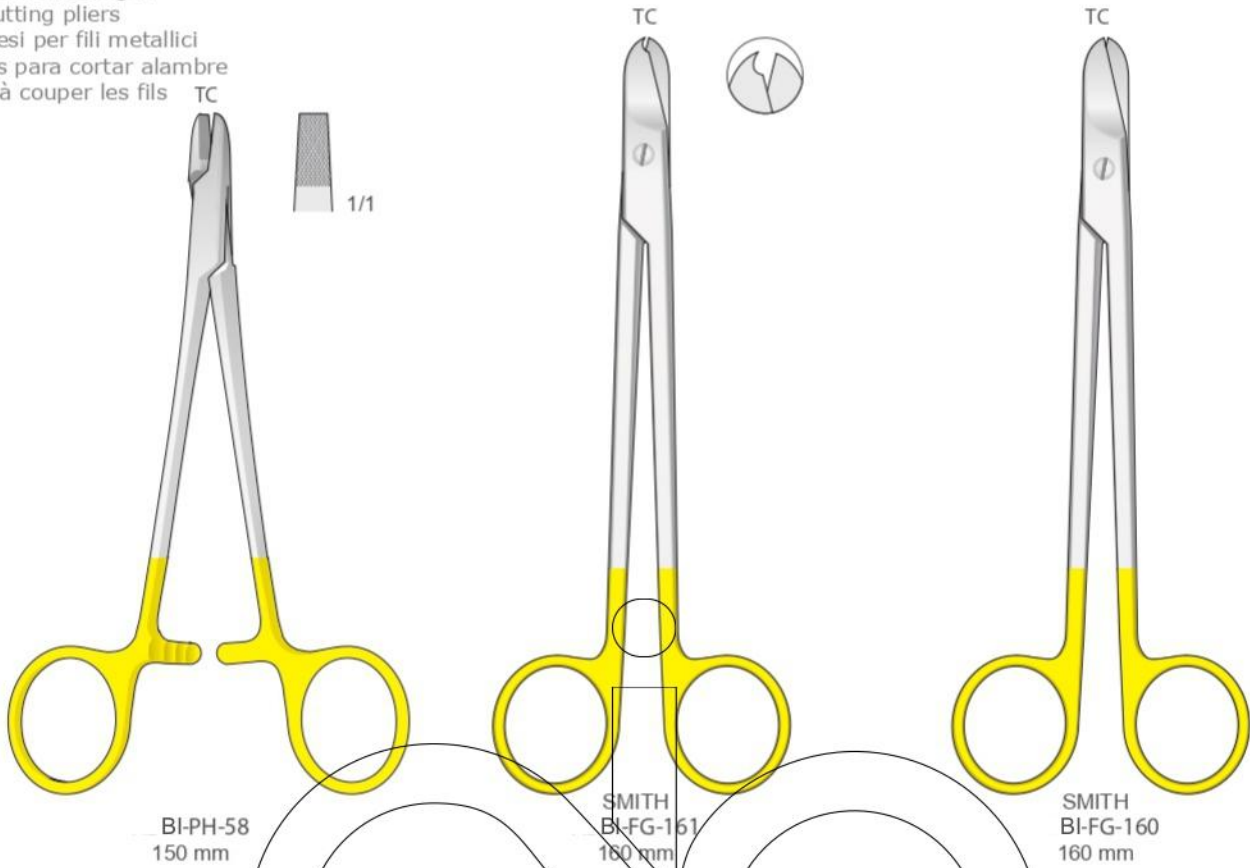

BI-PH-58
150 mm

SMITH
BI-FG-161
160 mm

SMITH
BI-FG-160
160 mm

Tungsten-Carbide Inserts
Mit Hartmetalleinsätzen
Plaquettes en carbure de tungstène
Plaquetas de carburo de tungsteno
Inserti in carburo di tungsteno

TC

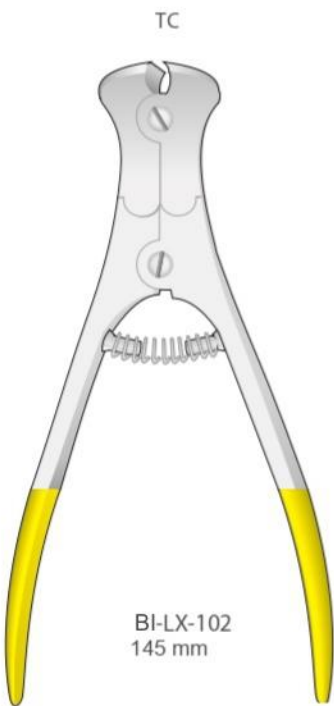

BI-LX-102
145 mm

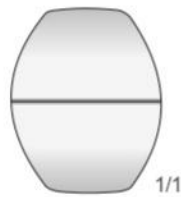

○ Max Ø 2.0 mm (.078")

Für weichen Draht
For soft Wire
Per filo leggero
Para alambre blando
Pour fil léger

○ Max Ø 1.5 mm (.059")

Für harten Draht
For hard Wire
Per filo duro
Para alambre duro
Pour fil dur

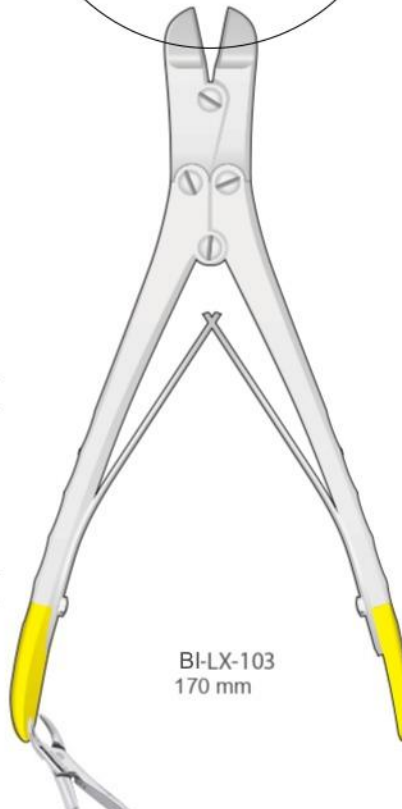

BI-LX-103
170 mm

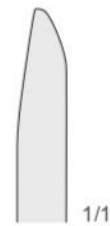

○ Max Ø 2.0 mm (.078")

Für weichen Draht
For soft Wire
Per filo leggero
Para alambre blando
Pour fil léger

○ Max Ø 1.5 mm (.059")

Für harten Draht
For hard Wire
Per filo duro
Para alambre duro
Pour fil dur

Scheren
Scissors
Forbici
Tijeras
Ciseaux

Scheren für dünne Stahl-und Edelmetallbleche - Scissors for thin steel and precious metal sheets
Forbici per lamine sottili di acciaio e metalli preziosi - Tijeras para láminas delgadas de acero y metales preciosos
Ciseaux pour couper les feuilles de métaux

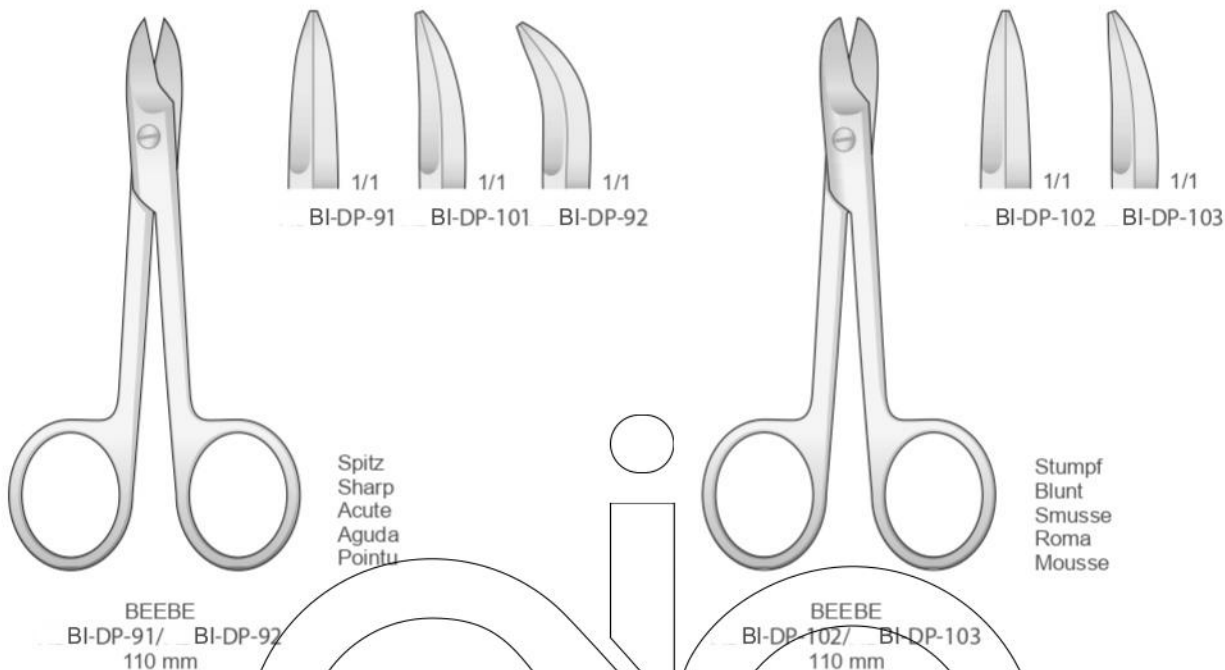

Scheren für dünne Stahl-und Edelmetallbleche - Scissors for thin steel and precious metal sheets
Forbici per lamine sottili di acciaio e metalli preziosi - Tijeras para láminas delgadas de acero y metales preciosos
Ciseaux pour couper les feuilles de métaux

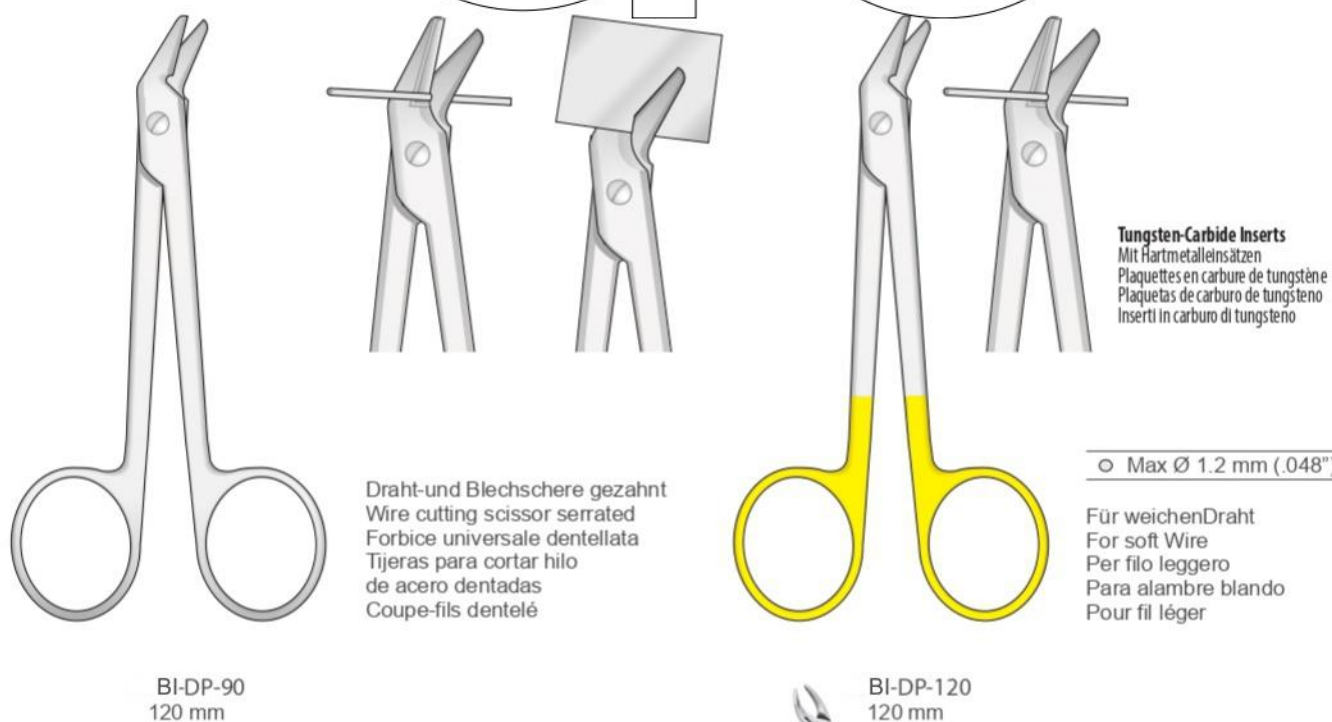



Separierzangen
Separating Pliers
Pinze tendielastici
Pinza estira-elásticos
Pince à separer

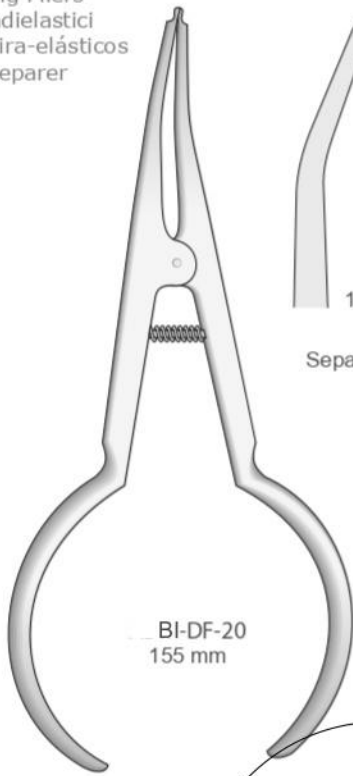

BI-DF-20
155 mm



1/1



Separierzange, zum Einbringen von Gummi-Separierligaturen
Separating forceps for inserting elastic separators
Pinze per legature per separatori elastici
Pinza para ligaduras estira-elásticos
Pince à separer les ligatures



1/1

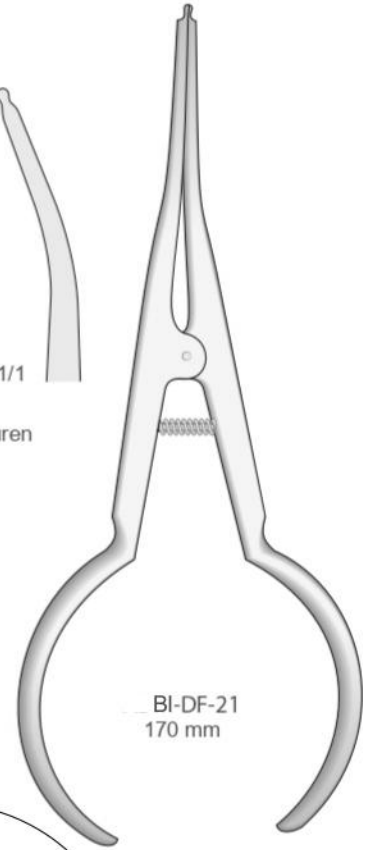

BI-DF-21
170 mm

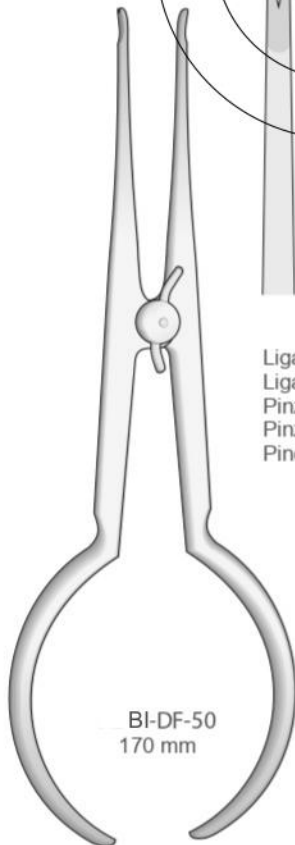
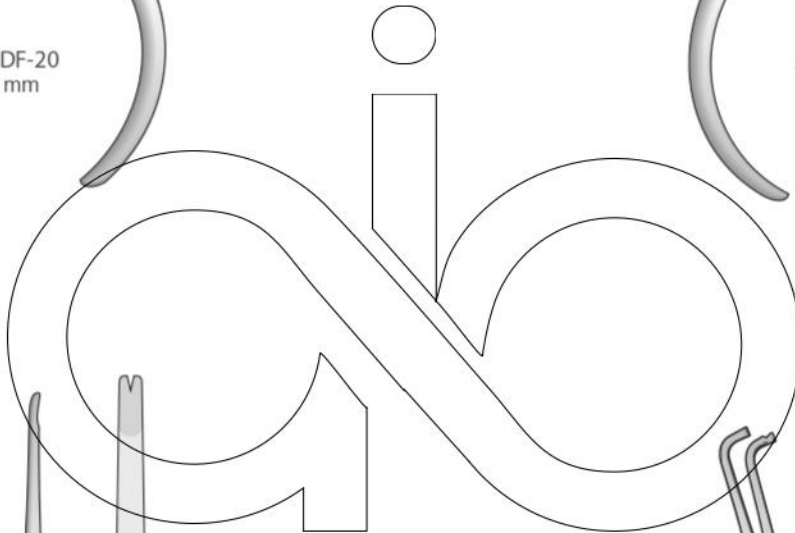

BI-DF-50
170 mm



1/1

Ligaturenspannzange
Ligature Tying Plier
Pinza per legature
Pinza para ligaduras
Pince à serrer les ligatures



BI-DP-150
160 mm

Bracketset Pinzette
Bonding Bracket Forceps
Pinzette per brackets
Pinza fina para ligar brackets
Fine pince à lier des boîtiers

5.0
4.0
0



Aluminium
 Aluminium
 Aluminium
 Aluminio
 Alluminio

BI-DP-100
 170 mm

Bracketpositionier
 Bracket Positioning Gauge
 Posizionatore per attacchi
 Posicionador de Brackets
 Positionateur des Brackets

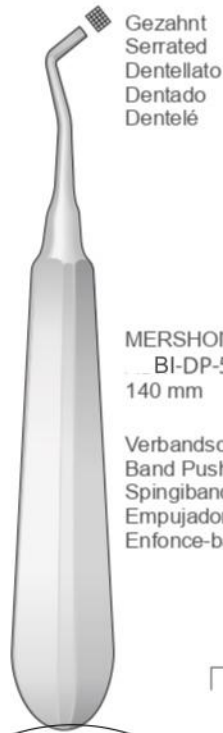

Gezahnt
 Serrated
 Dentellato
 Dentado
 Dentelé

MERSHON
 BI-DP-50
 140 mm

Verbandschieber
 Band Pusher
 Spingibande
 Empujador de bandas
 Enforce-bague

Utility Instrumente
 Utility Instruments
 Strumenti di utilità
 Instrumentos para utilidad
 Instruments pour utility

BI-DP-100
 170 mm



SHURE
 BI-DP-124
 175 mm

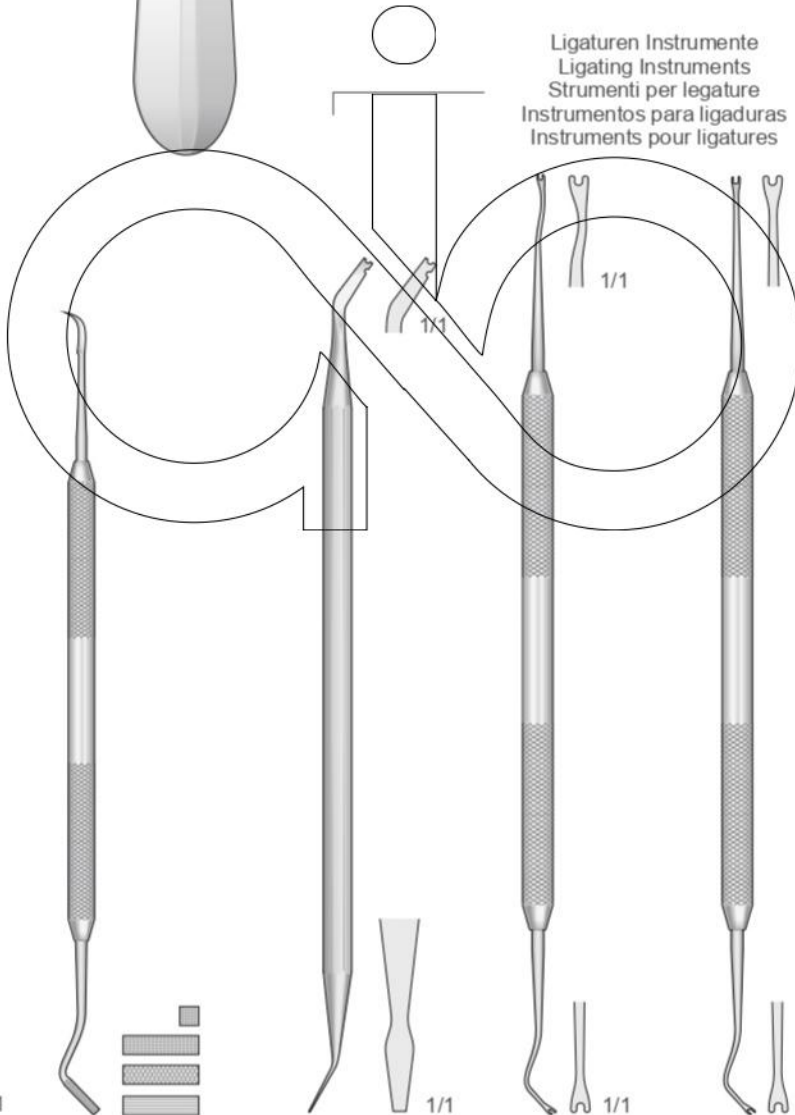

Ligaturen Instrumente
 Ligating Instruments
 Strumenti per legature
 Instrumentos para ligaduras
 Instruments pour ligatures

BI-DP-54
 175 mm

BI-DP-125
 155 mm

BI-PF-1
 170 mm

BI-PF-2
 170 mm

BI-PF-3
 160 mm

Ligature Instruments
Ligating Instruments
Strumenti per legature
Instrumentos para ligaduras
Instruments pour ligatures

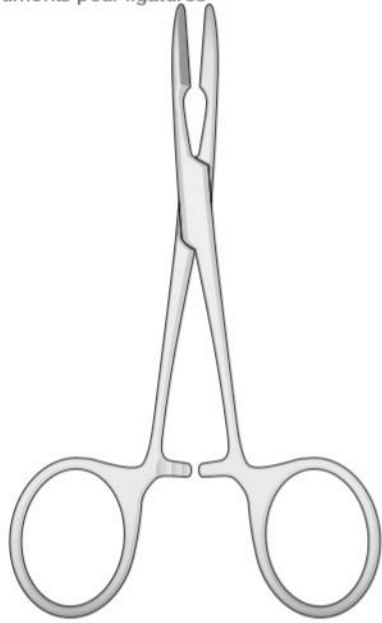

PEAN-MURPHY
BI-BF-22
130 mm

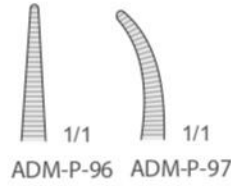
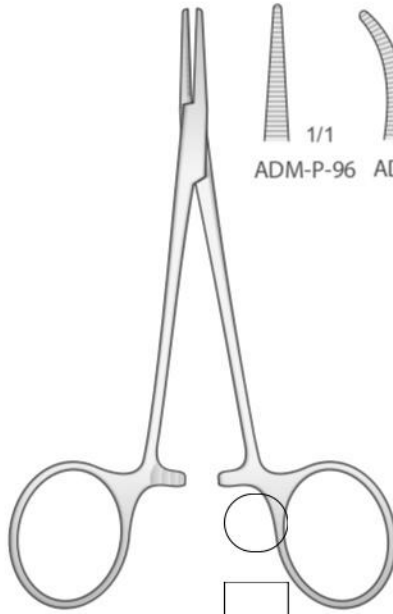

HALSTED-MOSQUITO
BI-P-96/ BI-P-97
120 mm



BI-COLLEGE
150 mm



MILLER
BI-DR-78
145 mm

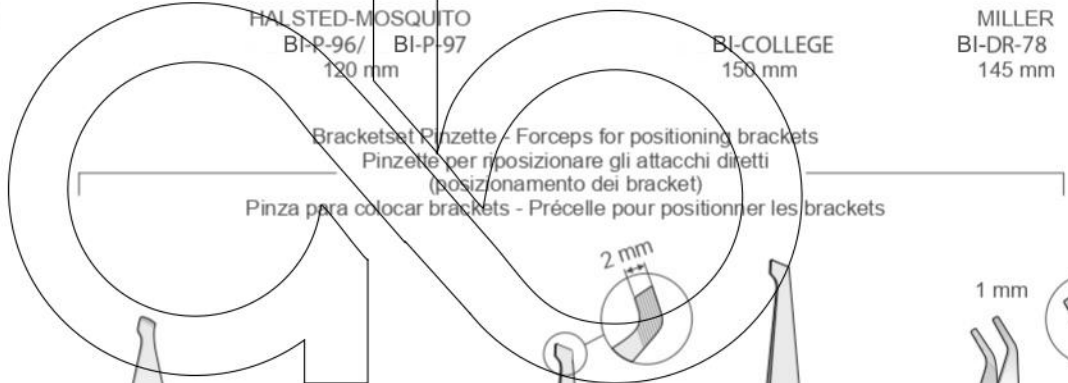

Bracket Gauge
Stainless Steel



BI-DP-132
130 mm



BI-DP-133
130 mm



BI-DP-52
130 mm



BI-DP-126
110 mm



BI-DP-127
125 mm



BI-DP-128
145 mm



BI-DP-129
130 mm

Messinstrumente
 Measuring Instruments
 Strumenti per misura
 Instrumentos de medición
 Instruments à mesurer

Dental-Schieblehre für Praxis und Labor
 Gauge Caliper for practice and laboratory
 Calibri dentali per studio e laboratorio
 Calibrador dental para práctica y el laboratorio
 Gauge calibreur pour practice et laboratoire

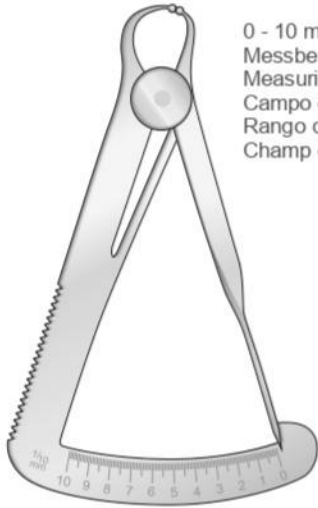

0 - 10 mm
 Messbereich
 Measuring range
 Campo di misura
 Rango de medición
 Champ de mesure

IWANSON
 BI-DP-721
 100 mm

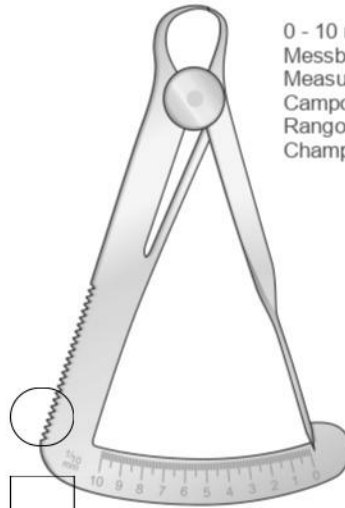

0 - 10 mm
 Messbereich
 Measuring range
 Campo di misura
 Rango de medición
 Champ de mesure

IWANSON
 BI-DP-720
 100 mm

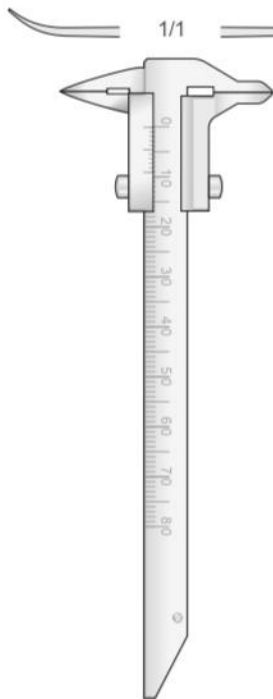

BI-DP-723
 80 mm

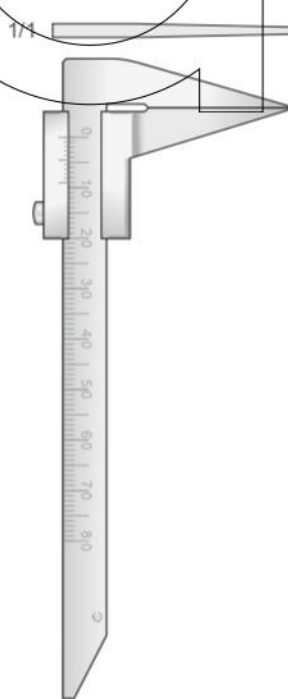

BI-DP-724
 80 mm



ZIELINSKY
 BI-DP-725
 110 mm

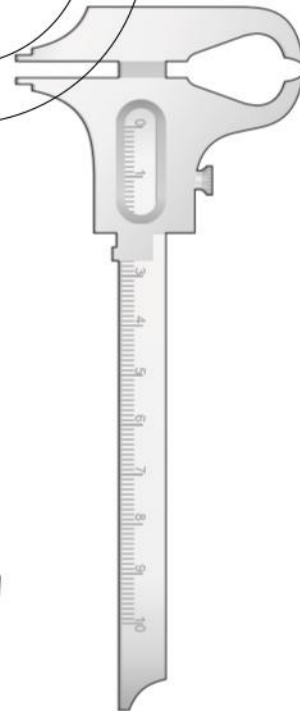

BOLEY
 BI-DP-730
 140 mm

0 - 100 mm
 Messbereich
 Measuring range
 Campo di misura
 Rango de medición
 Champ de mesure



Zubehör
Accessories
Accessori
Accesorios
Accessoires

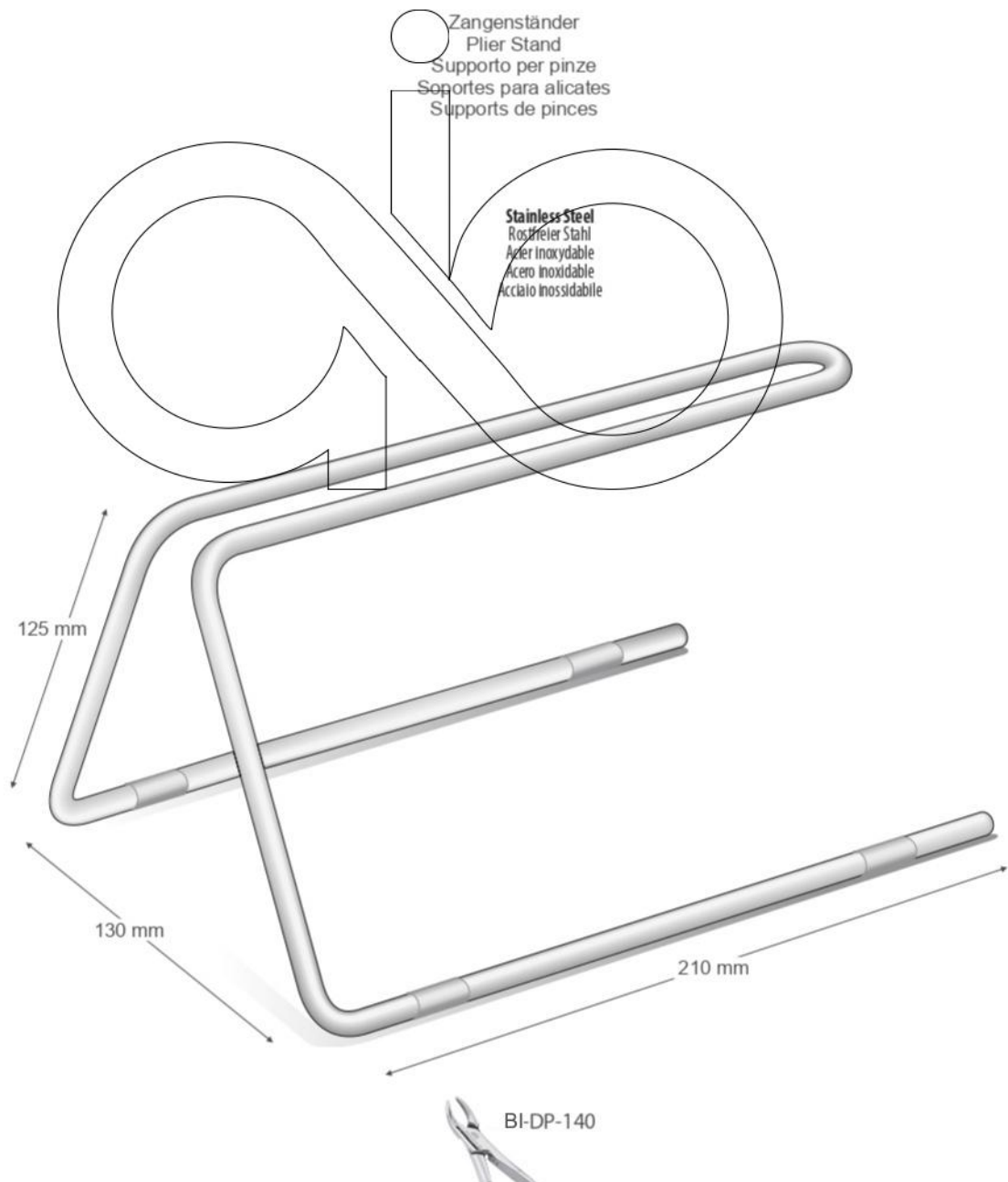
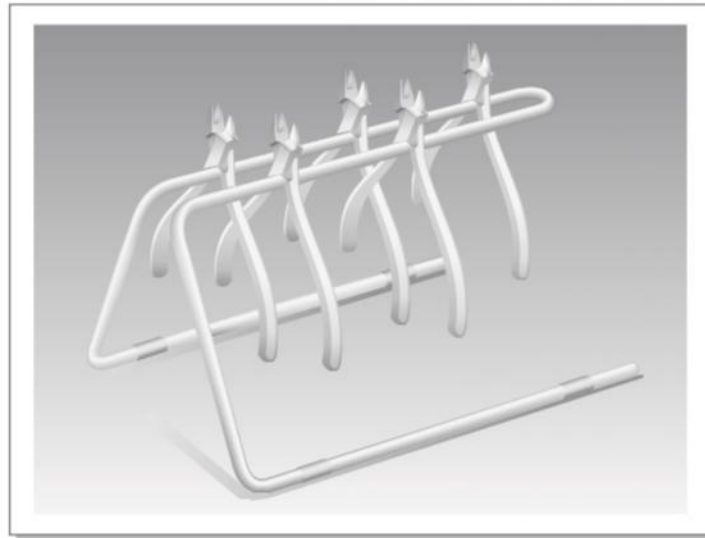



ALL IN ONE

S U P P L I E S

Manufacturer & Exporter Of Surgical, Dental & Orthopedic Instruments.

+92-333-8740-629

info@aio supplies.com | medisuraj@gmail.com

Bismillah Street, Kacha Shahab Pura, S.I.E. Sialkot Pakistan www.aio supplies.com



ISO
9001:2008

