

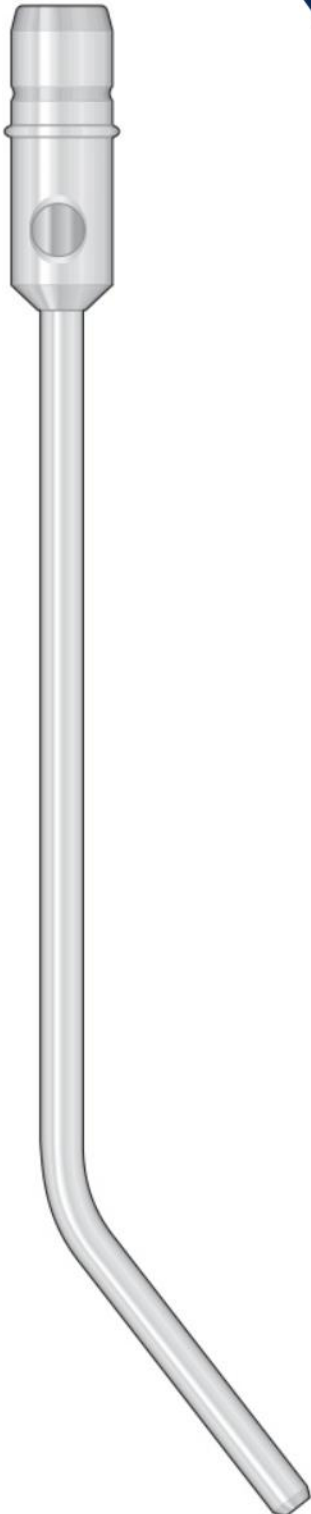

**ALL IN ONE**  
**SUPPLIES**



**CATALOGUE**

# Suction Tube



Saugkanülen  
Suction Tubes  
Cannule per aspirazione  
Cánulas de aspiración  
Canules d'aspiration

**Stainless Steel**  
Rostfreier Stahl  
Acier inoxydable  
Acero inoxidable  
Acciaio inossidabile

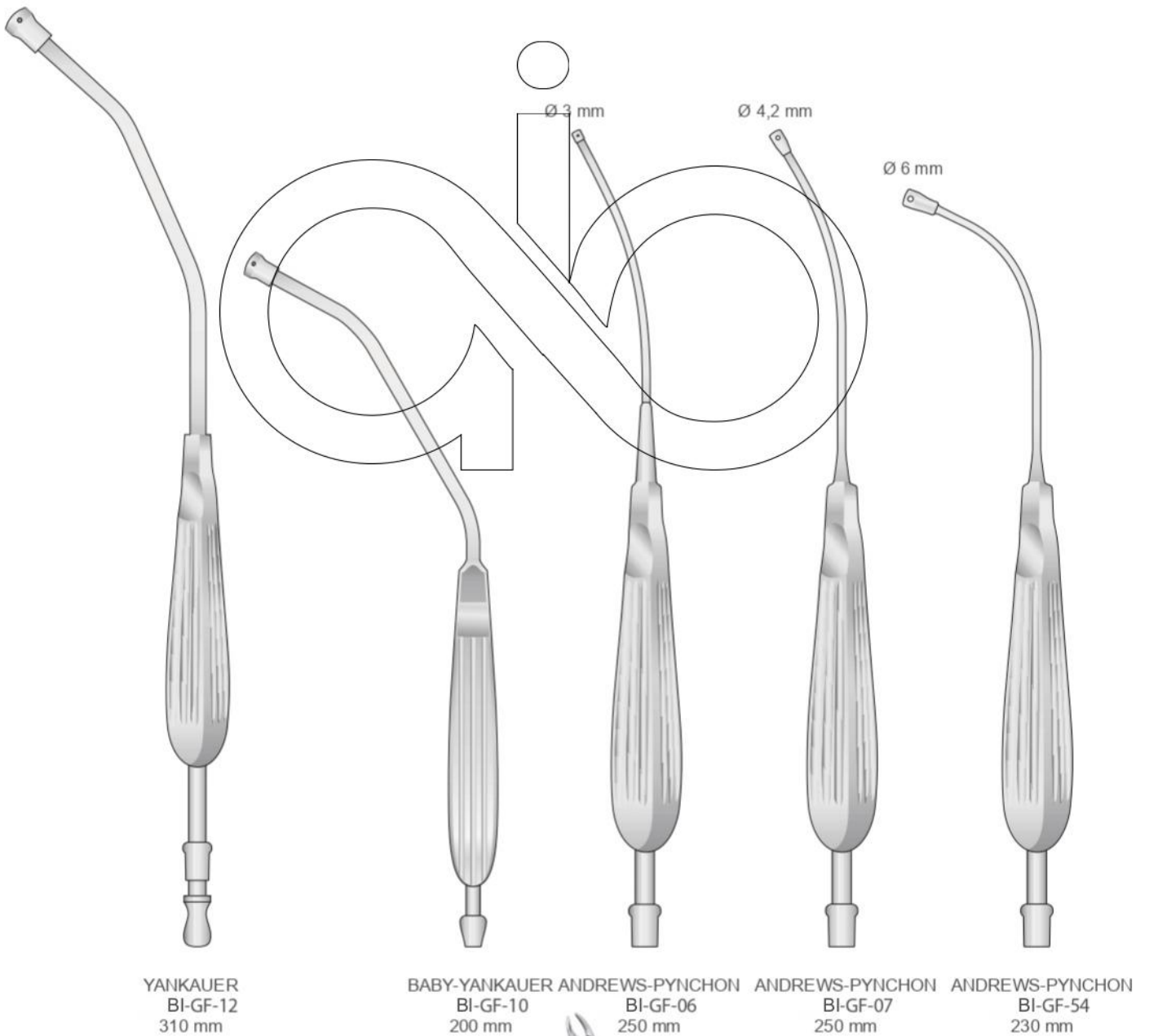

Stainless Steel  
Rostfreier Stahl  
Acier inoxydable  
Acero inoxidable  
Acciaio inossidabile

Saugkanülen  
Suction Tubes  
Cannule per aspirazione  
Cánulas de aspiración  
Canules d'aspiration

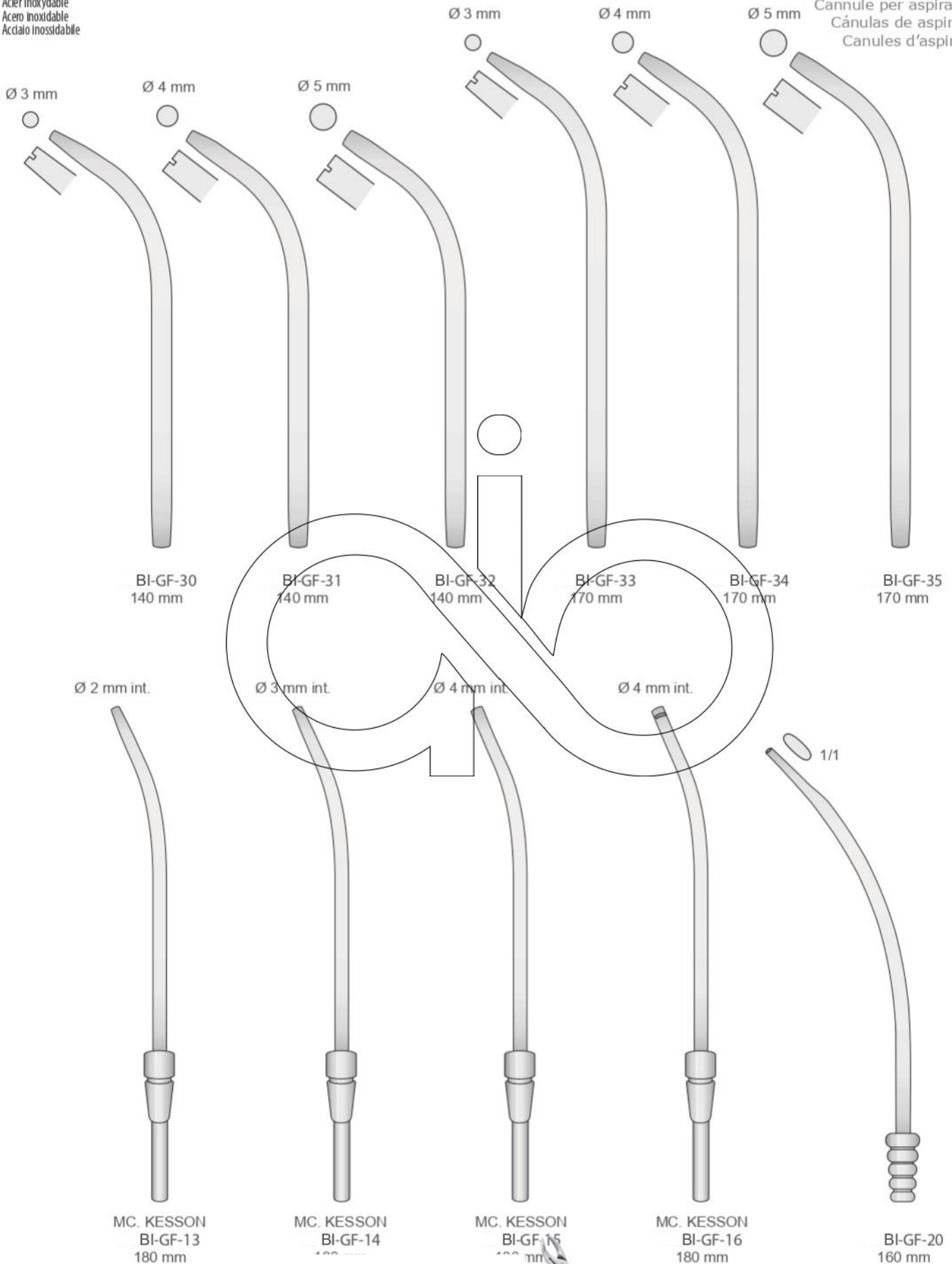



Saugkanülen  
Suction Tubes  
Cannule per aspirazione  
Cánulas de aspiración  
Canules d'aspiration

**Stainless Steel**  
Rostfreier Stahl  
Acier inoxydable  
Acero inoxidable  
Acciaio inossidabile

Ø 1 mm    Ø 1,5 mm    Ø 2,5 mm    Ø 3,5 mm int.



**BI-TS-40**  
Connection piece for suction  
75 mm - 100% Stainless Steel

HVS  
Adaptor  
Adapter  
Adattatore  
Adaptador  
Adaptateur



**COUPLAND**  
BI-GF-01  
150 mm



BI-GF-05  
95 mm

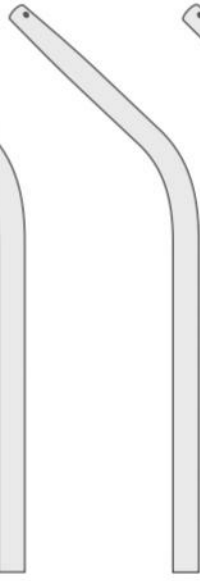

BI-GF-04  
95 mm

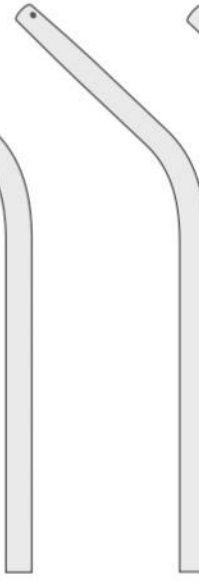

BI-GF-03  
95 mm

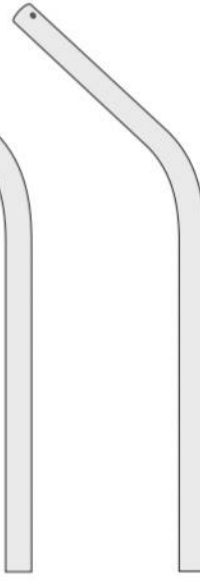

BI-GF-02  
95 mm

**COMPLETE SET**  
BI-GF-11  
( BI-GF-01 + BI-GF-02 + BI-GF-03  
+ BI-GF-04 + BI-GF-05)  
Griff + 4 Kanülen  
Handle + 4 tubes  
Manico + 4 cannule  
Mango + 4 cánulas  
Manche + 4 canules

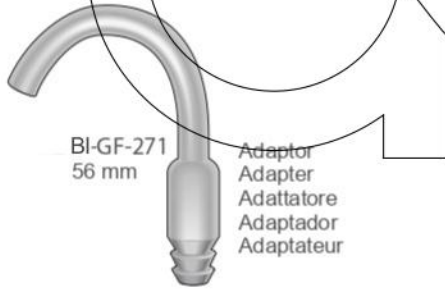

**BI-GF-271**  
56 mm  
Adaptor  
Adapter  
Adattatore  
Adaptador  
Adaptateur

Ø Ext. 6,0 mm  
Ø Int. 4,5 mm

Autoclavable Tubing  
Schlauch - Silikon  
Flexible Tube - Silicone  
Raccordo in silicone per cannule  
Tubo flexible de silicona  
Tuyau - Silicone

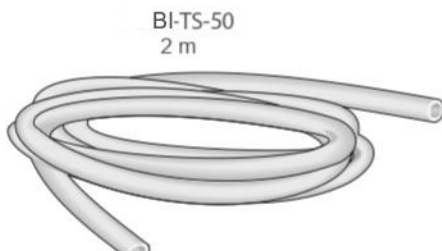

**BI-TS-50**  
2 m

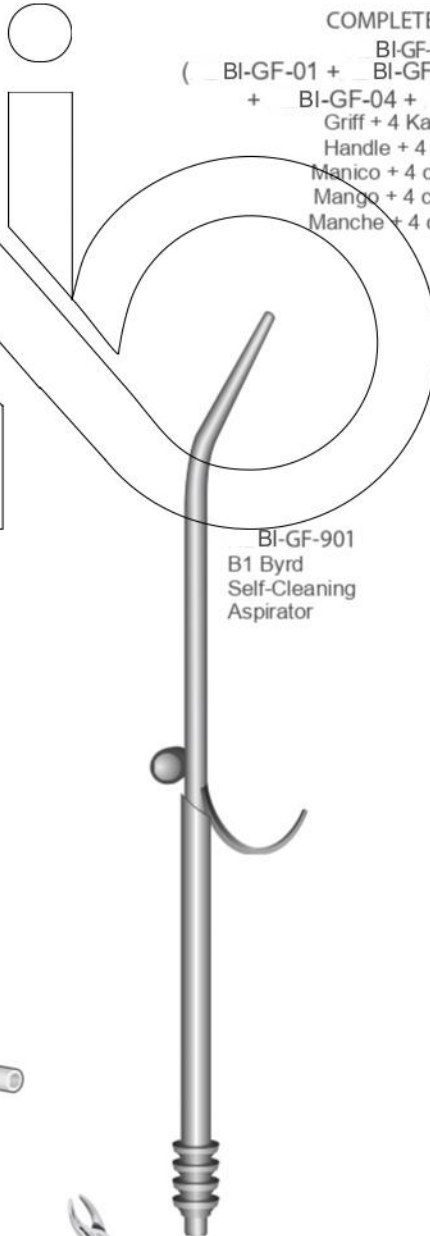

**BI-GF-901**  
B1 Byrd  
Self-Cleaning  
Aspirator

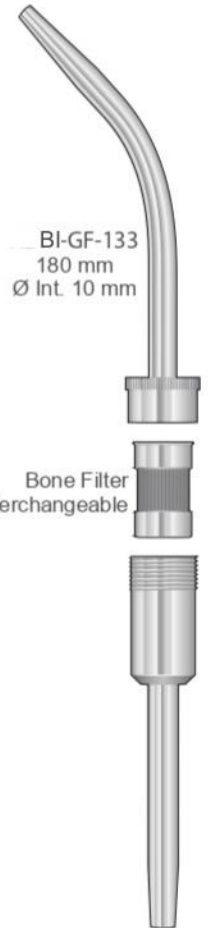

**BI-GF-133**  
180 mm  
Ø Int. 10 mm

Bone Filter  
interchangeable

Saugkanülen  
Suction Tubes  
Cannule per aspirazione  
Cánulas de aspiración  
Canules d'aspiration

**Stainless Steel**  
Rostfreier Stahl  
Acier inoxydable  
Acero inoxidable  
Acciaio inossidabile

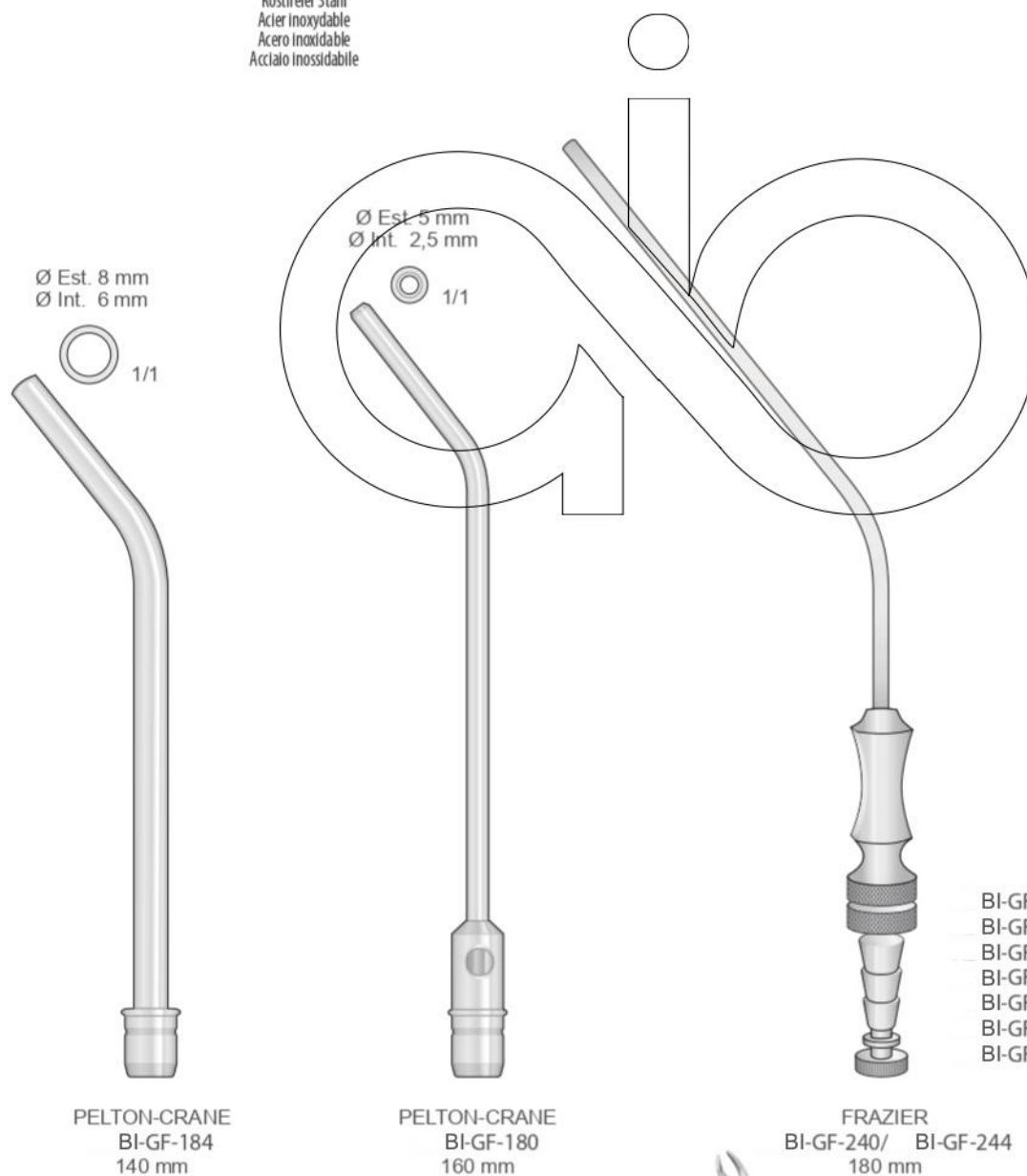



Saugkanülen  
Suction Tubes  
Cannule per aspirazione  
Cánulas de aspiración  
Canules d'aspiration

**Stainless Steel**  
Rostfreier Stahl  
Acier inoxydable  
Acero inoxidable  
Acciaio inossidabile

Flexible  
Flexibel  
Flexible  
Flexible  
Flessibile  
Ø 3 mm

Flexible  
Flexibel  
Flexible  
Flexible  
Flessibile  
Ø 3 mm

**Chromium Black**  
Schwarz-Chrom  
Chrom noir  
Cromado negro  
Cromato nero

WERTHEIMER  
BI-GF-69  
160 mm

FRAZIER  
BI-GF-70  
160 mm

FRAZIER  
BI-GF-61  
200 mm

WERTHEIMER  
BI-GF-60  
200 mm

ADSON  
BI-GF-41 ch. 12 Ø 4 mm  
BI-GF-42 ch. 15 Ø 5 mm  
210 mm

Kanülenreinigungs-Bürsten  
 Cleaning brush for Tubes  
 Scovolini per pulizia cannule  
 Cepillo para limpiar cánulas  
 Brosse de nettoyage pour canules



Bürsten  
 Brush  
 Spazzola  
 Cepillo  
 Brosse

Autoklav  
 Autoclavable  
 Autoclavabile  
 Autoclave  
 Autoclave

BI-GF-200  
 4 x 11 cm

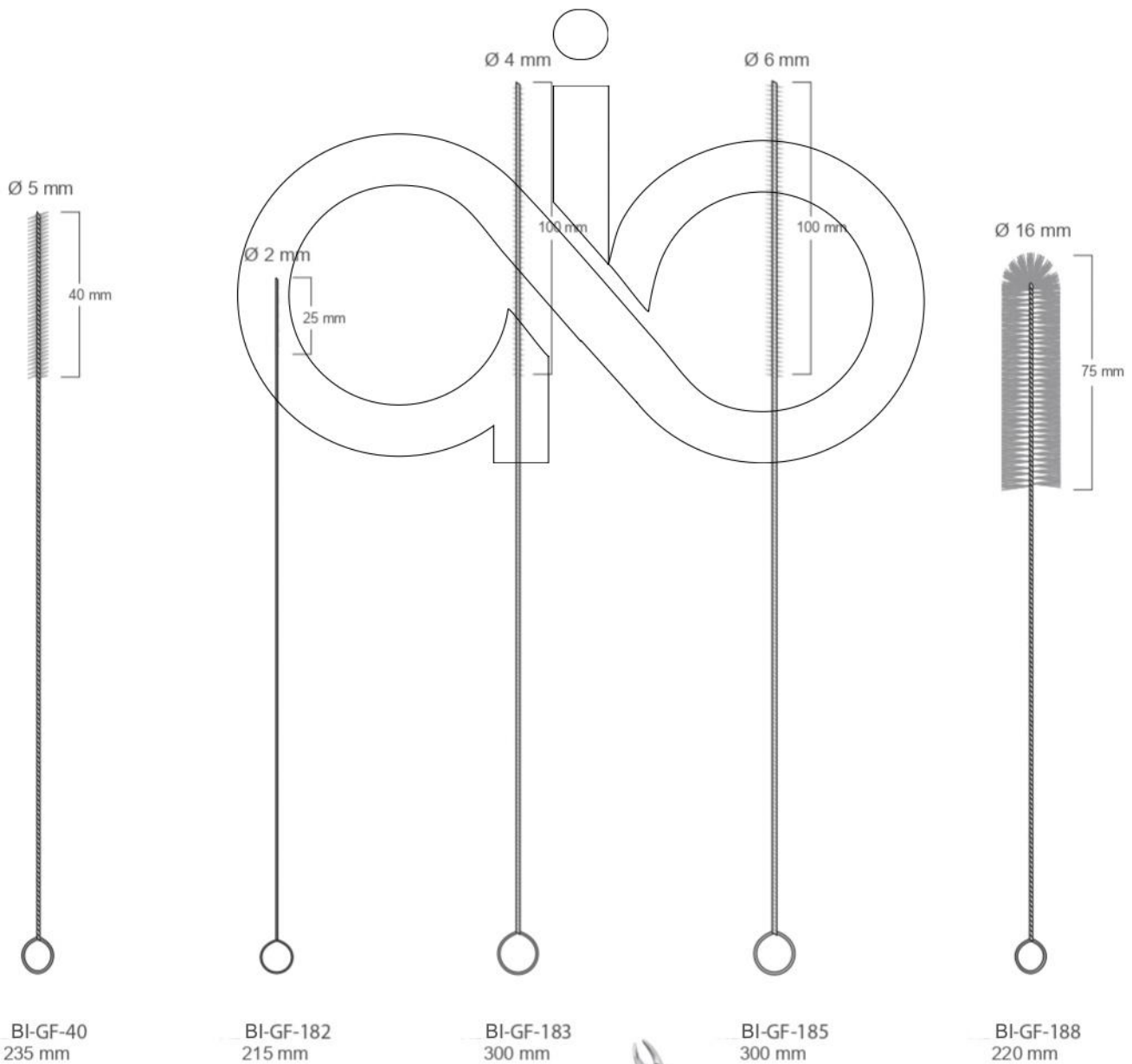



# **ALL IN ONE**

---

## **S U P P L I E S**

Manufacturer & Exporter Of Surgical, Dental & Orthopedic Instruments.

+92-333-8740-629

info@aiosupplies.com | medisuraj@gmail.com

Bismillah Street, Kacha Shahab Pura, S.I.E. Sialkot Pakistan [www.aiosupplies.com](http://www.aiosupplies.com)



ISO  
9001:2008

