



ALL IN ONE
SUPPLIES

2020
CATALOGUE



Tissue and Dressing Forceps instruments

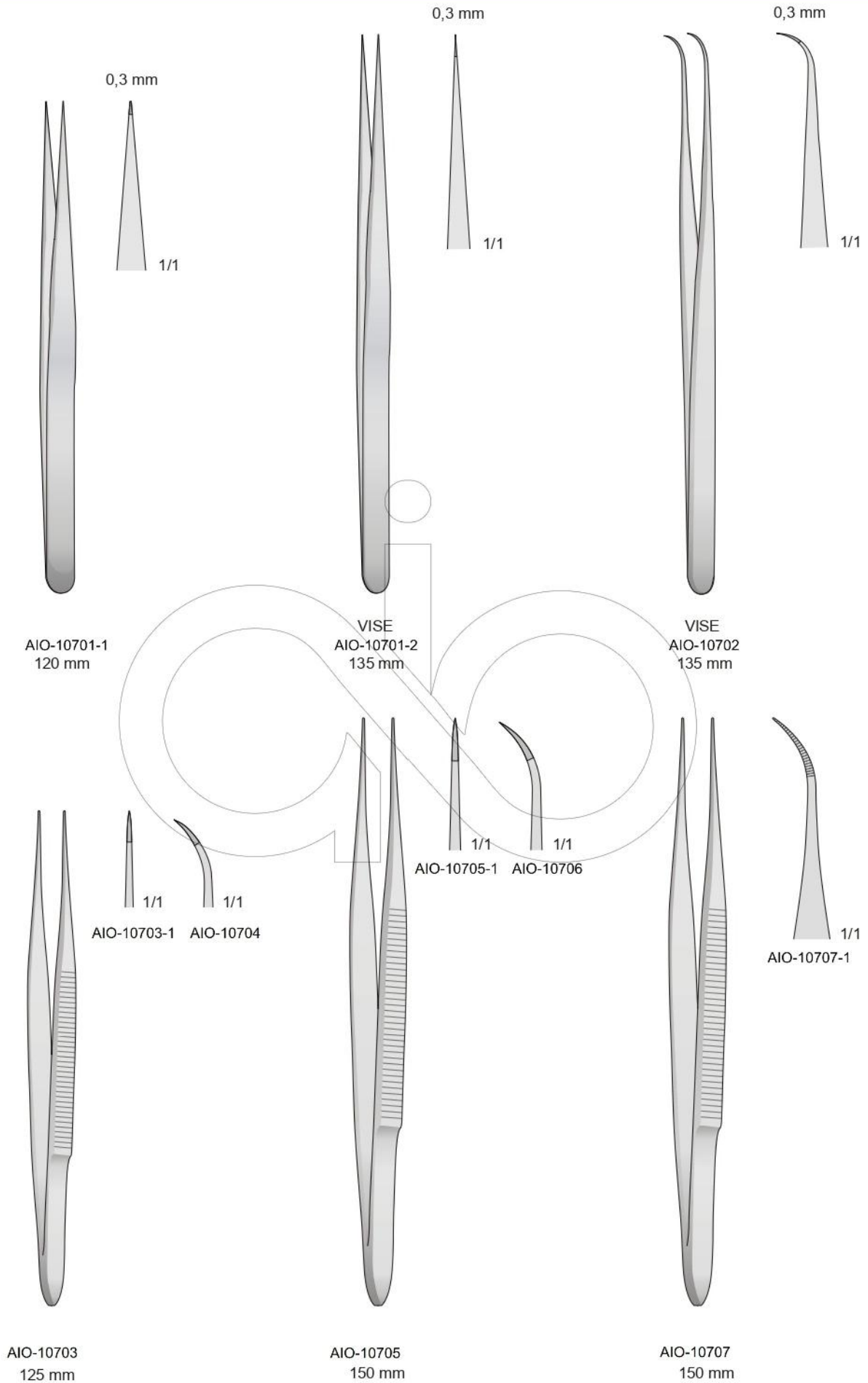

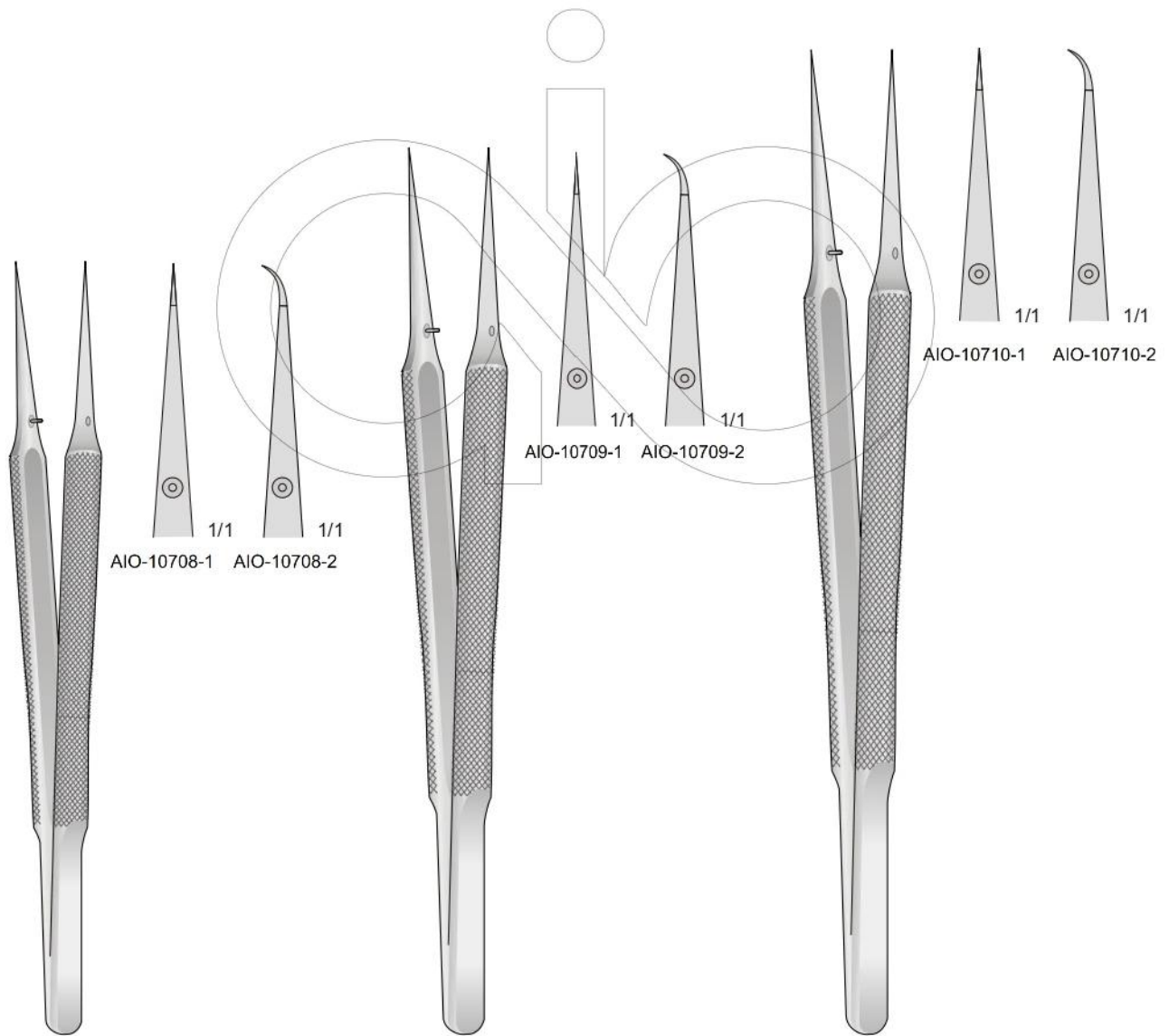

AIO-10708
120 mm

AIO-10709
150 mm

AIO-10710
180 mm

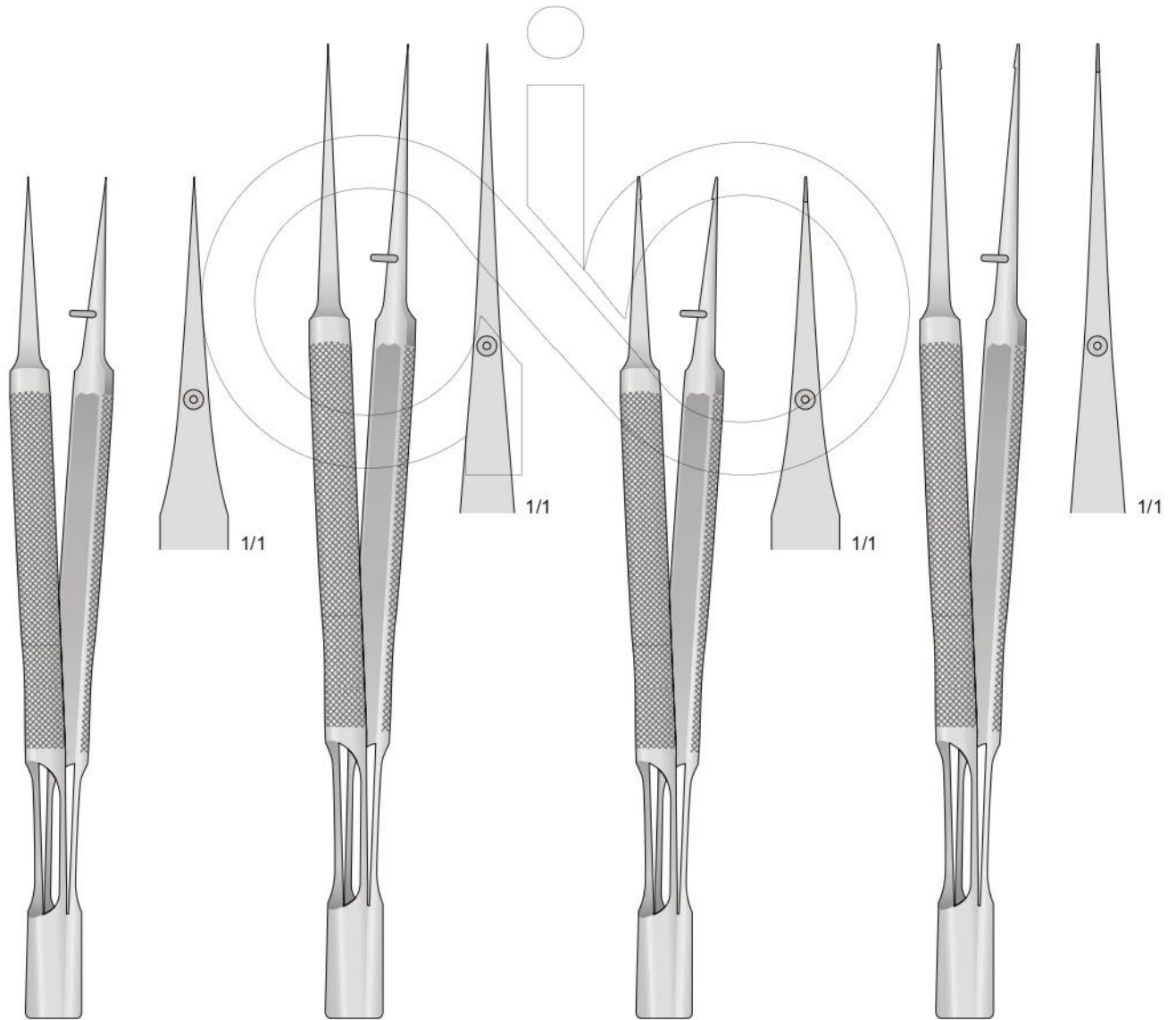
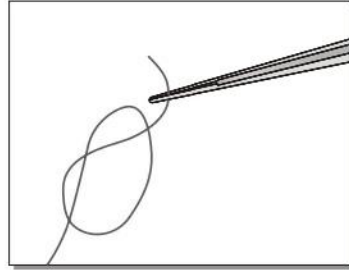

BROCK
AIO-10711
130 mm

BROCK
AIO-10712
150 mm

BROCK
AIO-10713
130 mm

BROCK
AIO-10714
150 mm

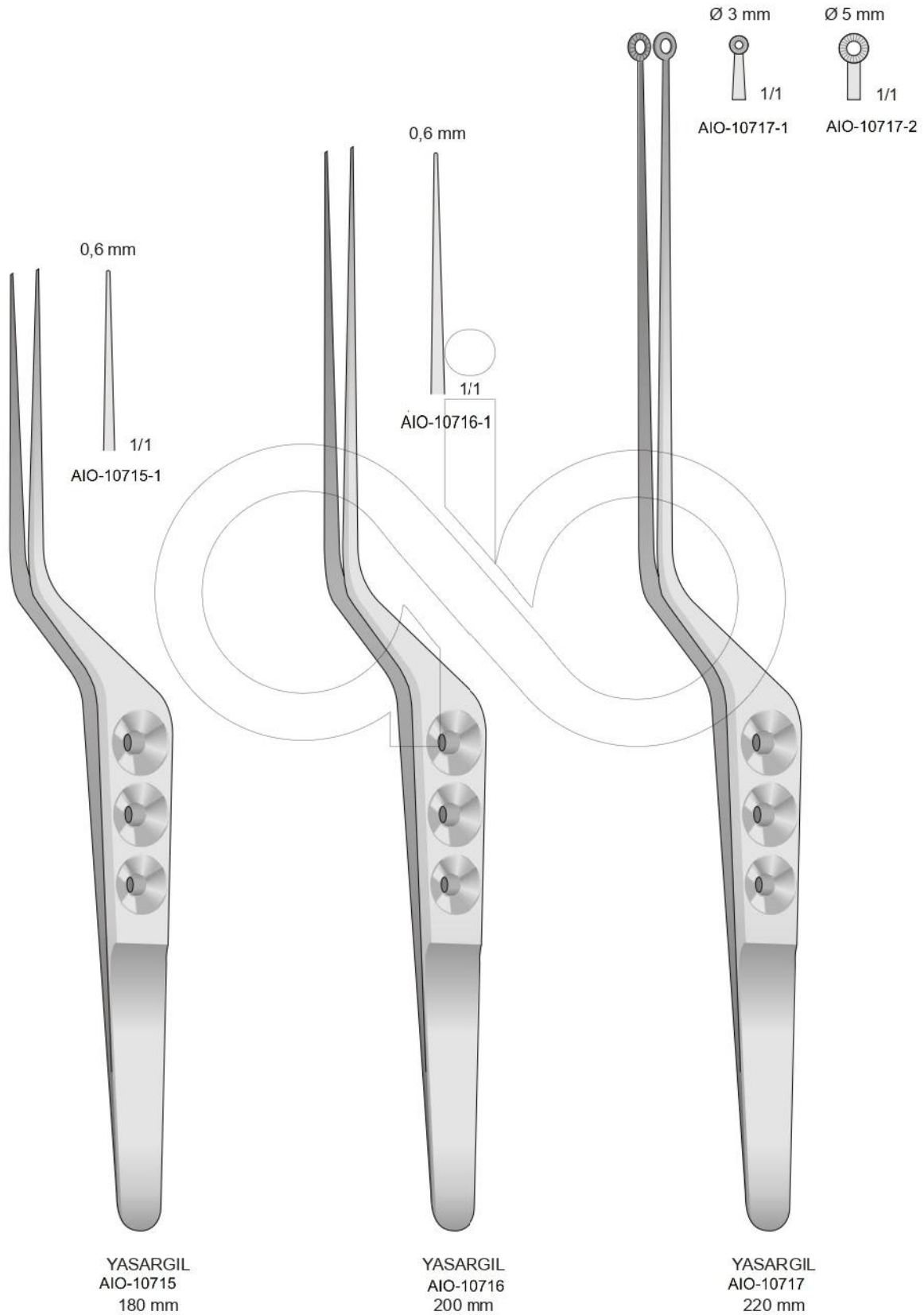

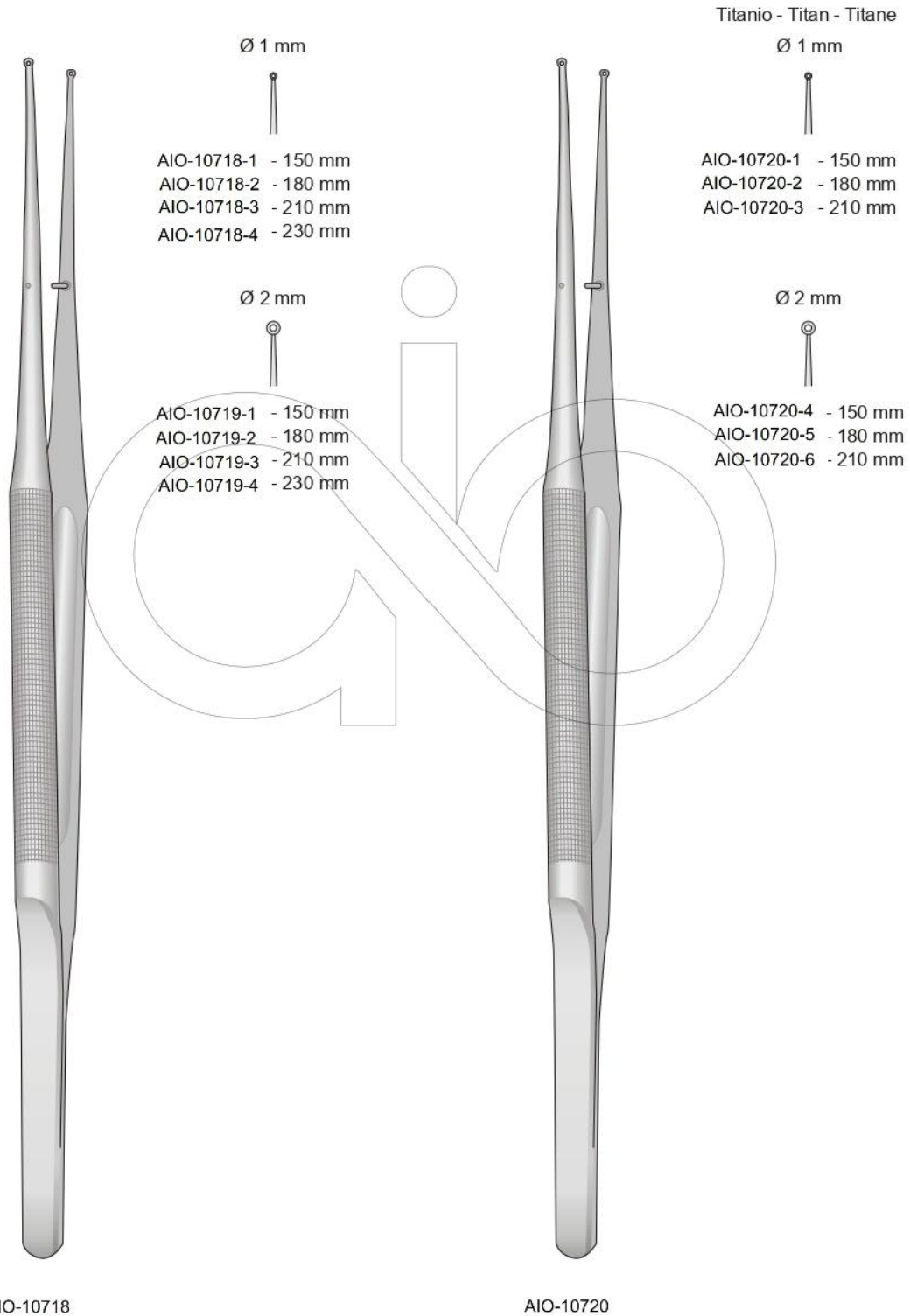

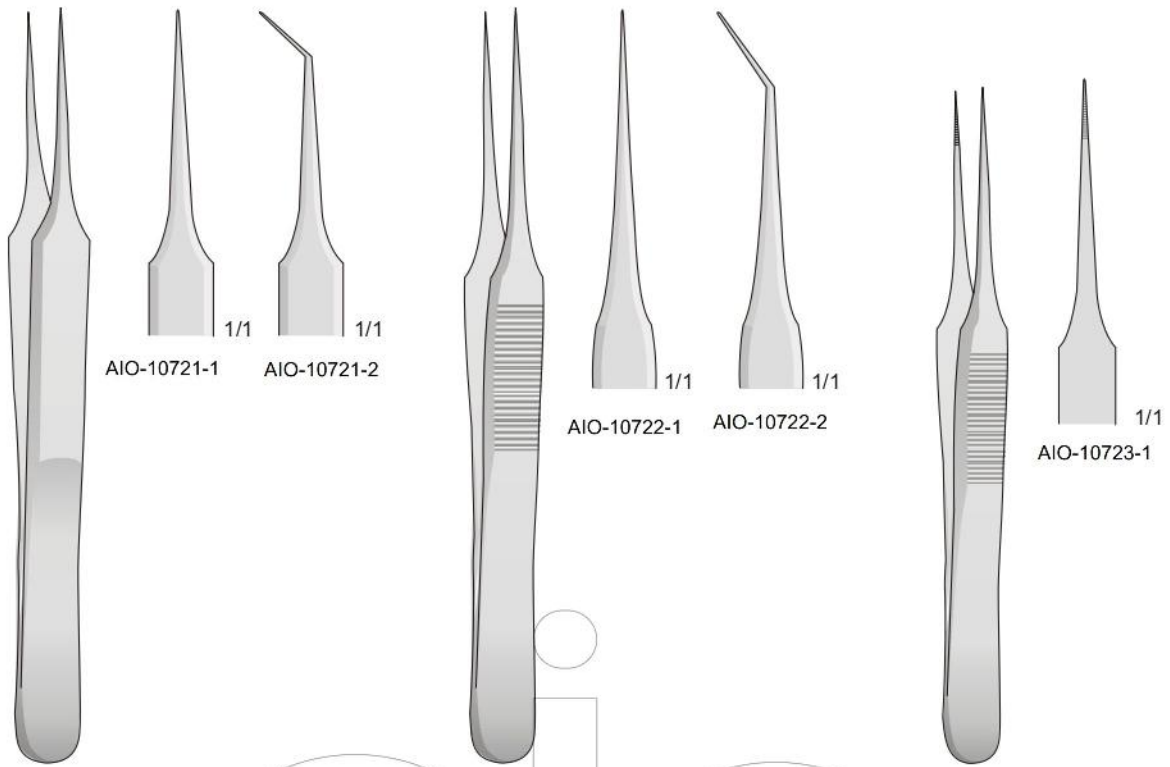

AIO-10721
110 mm

AIO-10722
110 mm

AIO-10723
90 mm

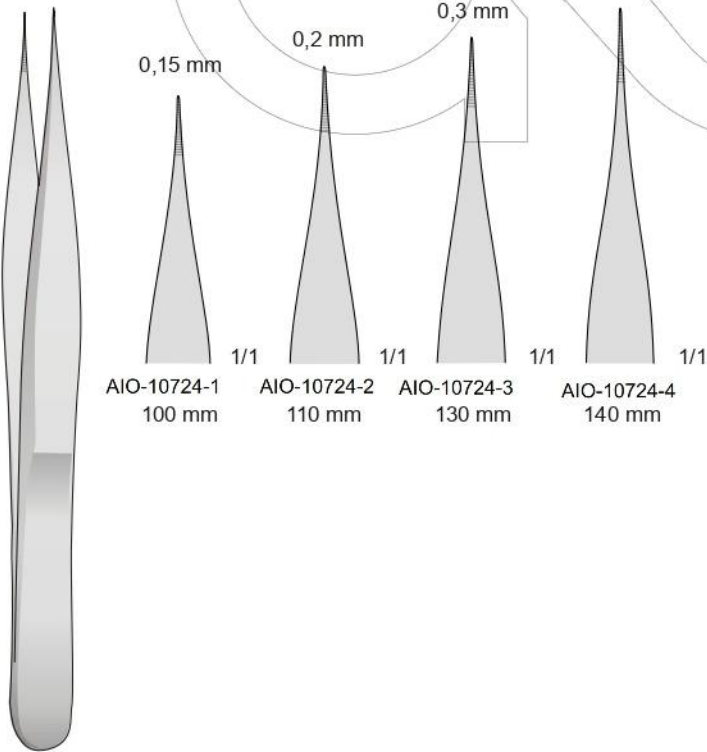
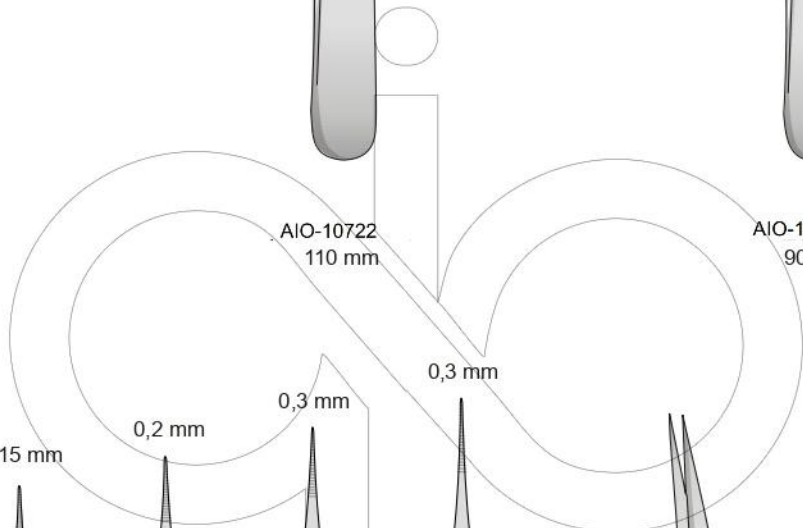

AIO-10724

AIO-10725
115 mm

AIO-10726
115 mm

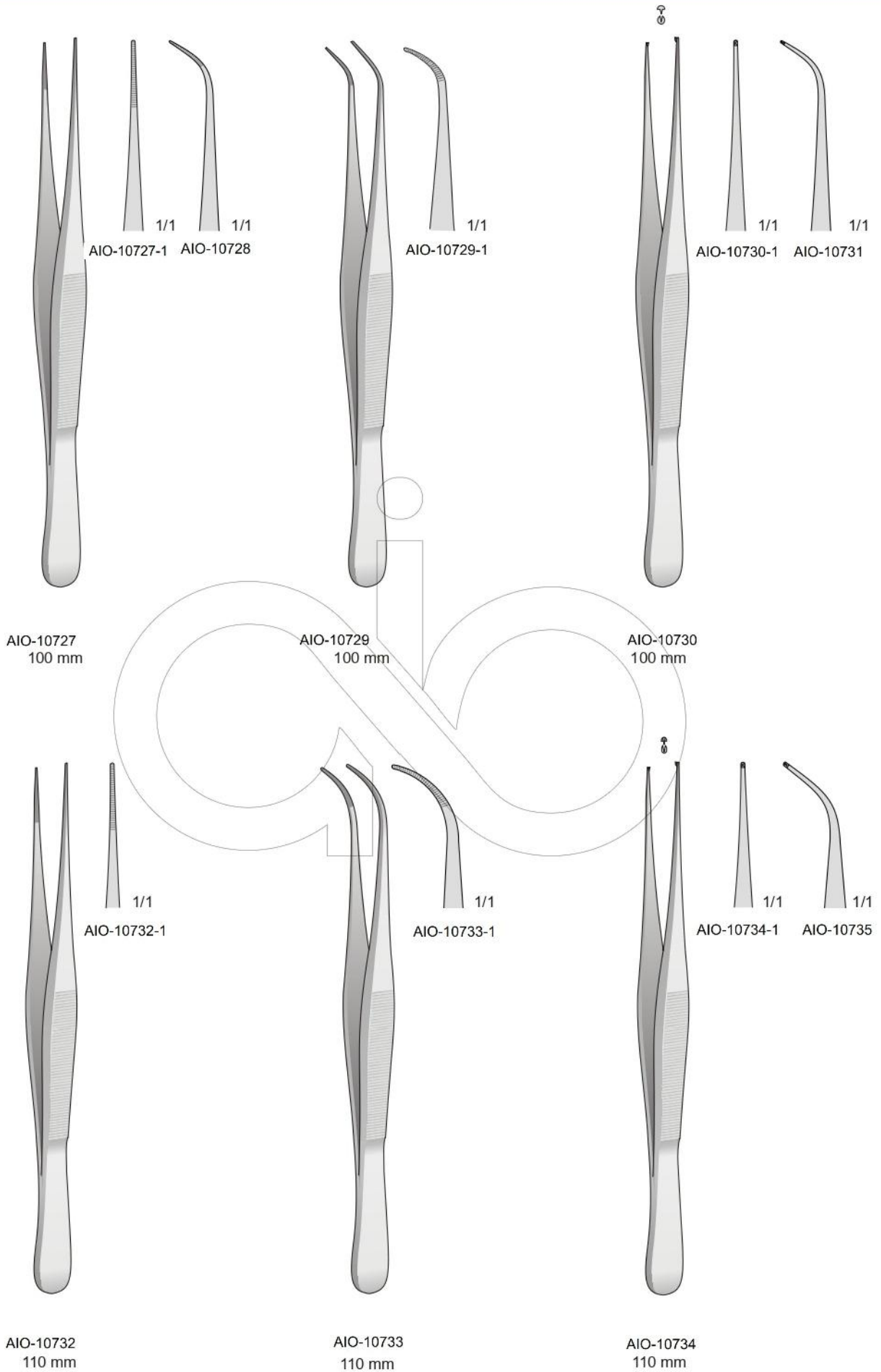

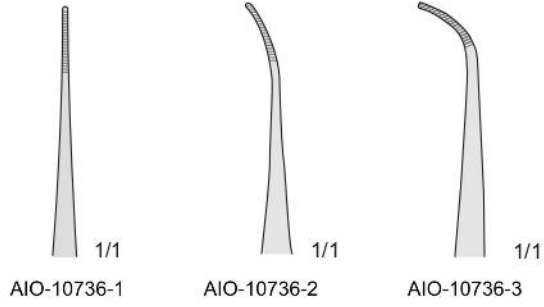

GRAEFE
AIO-10736
100 mm

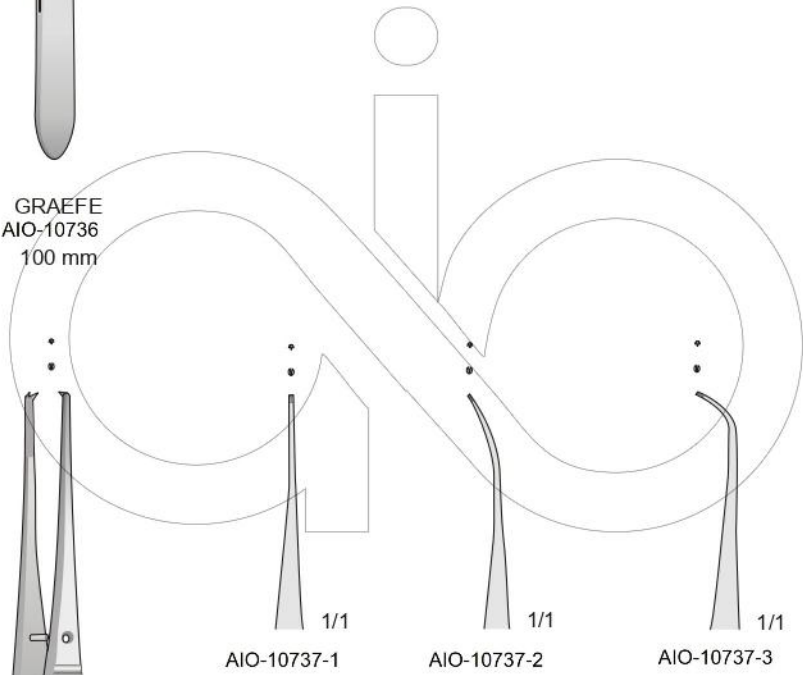

GRAEFE
AIO-10737
100 mm



PERRY
AIO-10738
125 mm

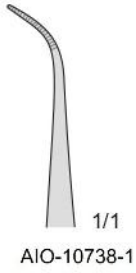

PERRY
AIO-10739
125 mm

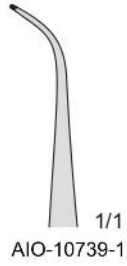

AIO-10740

1x2 denti
0,2 mm
1/1
AIO-10740-1
95 mm

0,8 mm



AUSTIN
AIO-10740-2
140 mm



AIO-10741
130 mm

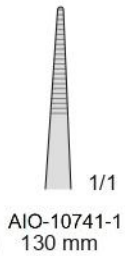

SEMKEN
AIO-10742
130 mm

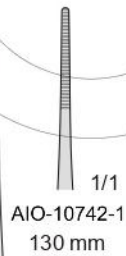

SEMKEN
AIO-10743
130 mm

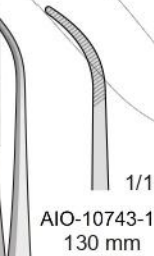

SEMKEN
AIO-10744
130 mm

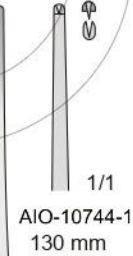

SEMKEN
AIO-10745
130 mm

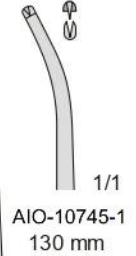

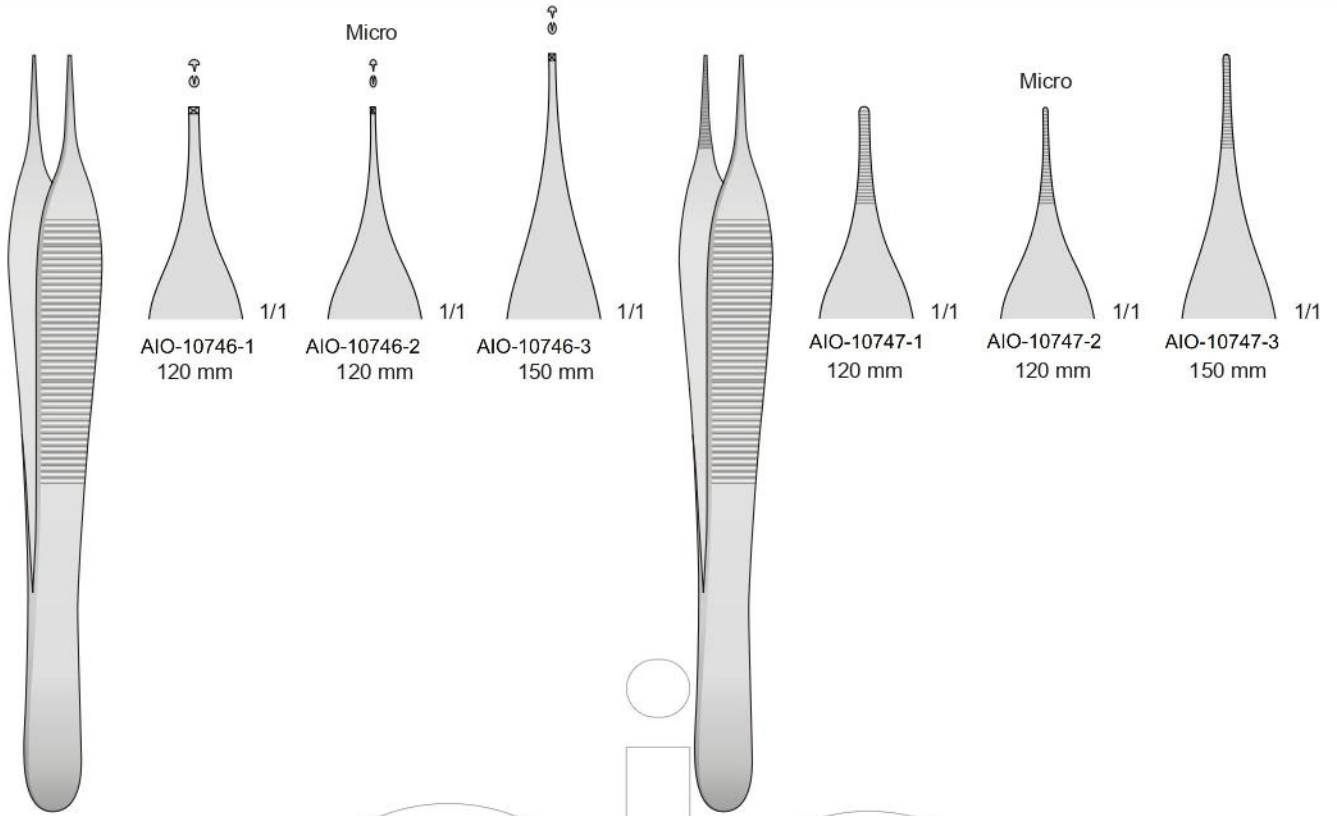

ADSON
AIO-10746

ADSON
AIO-10747

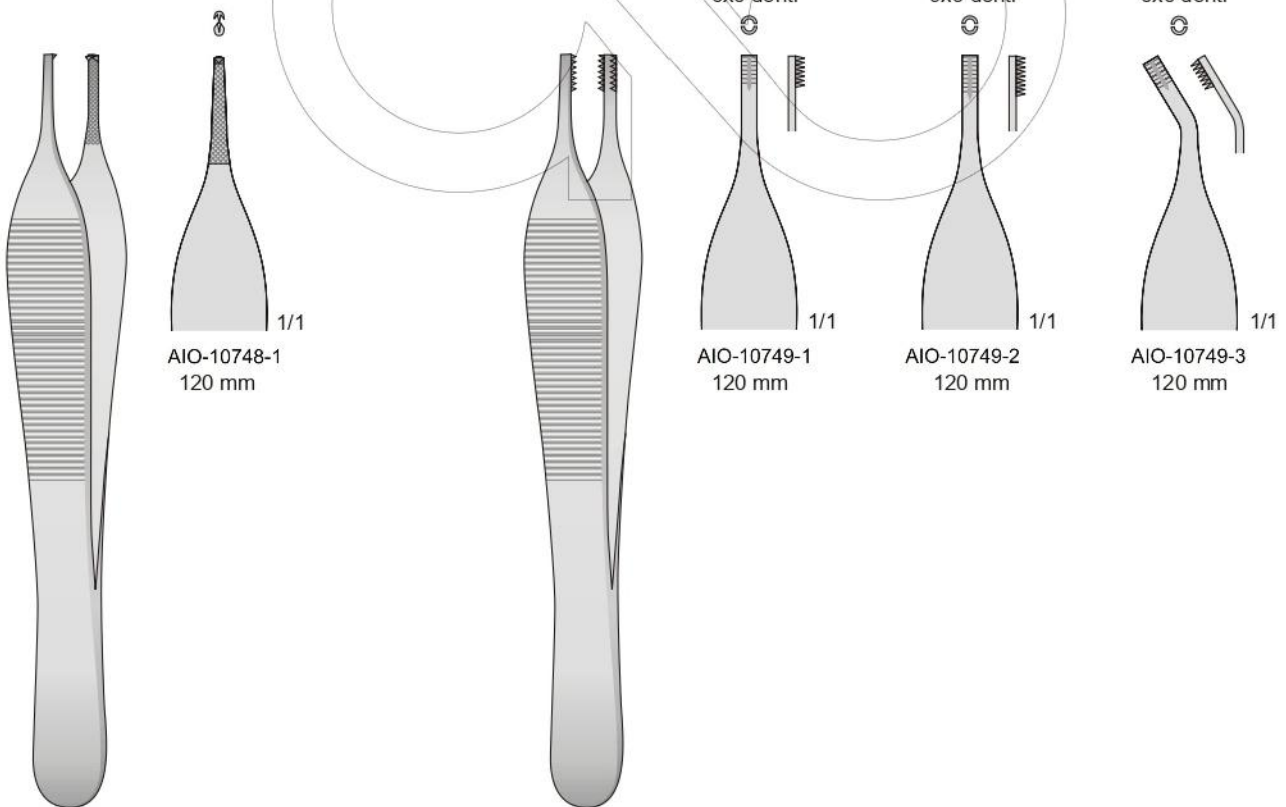

ADSON
AIO-10748
120 mm

ADSON-BROWN
AIO-10749
120 mm

AIO-10748-1
120 mm

AIO-10749-1
120 mm

AIO-10749-2
120 mm

AIO-10749-3
120 mm

Standard



AIO-10750

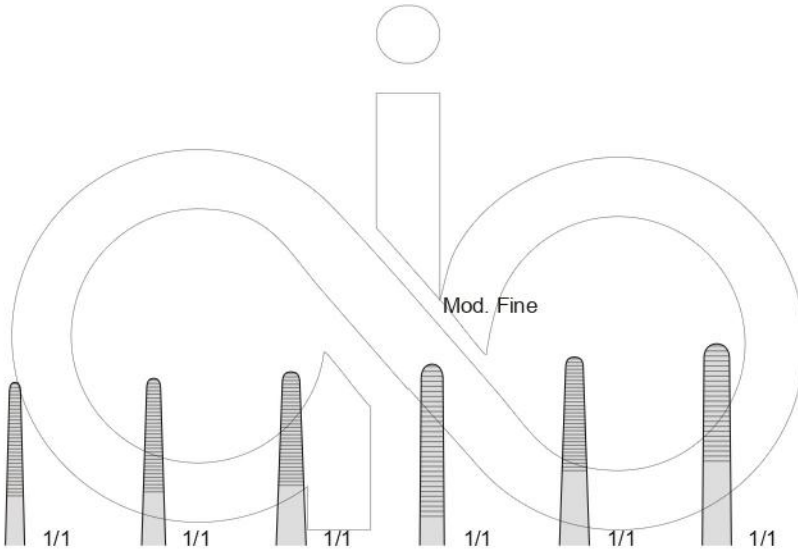
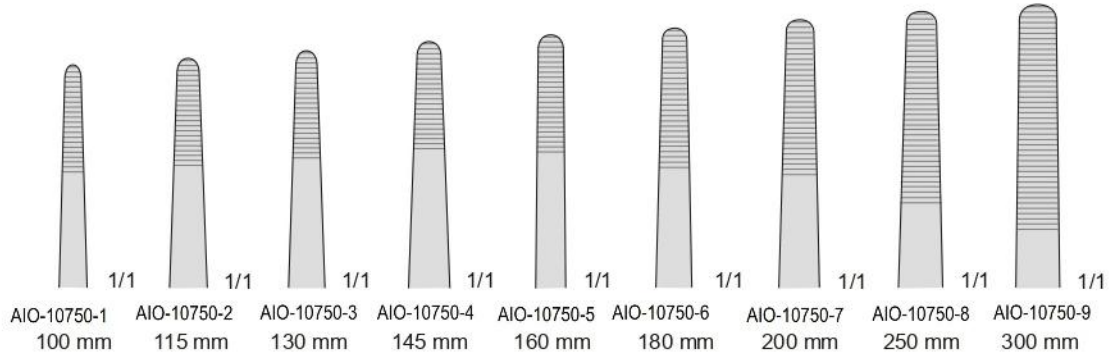

AIO-10751

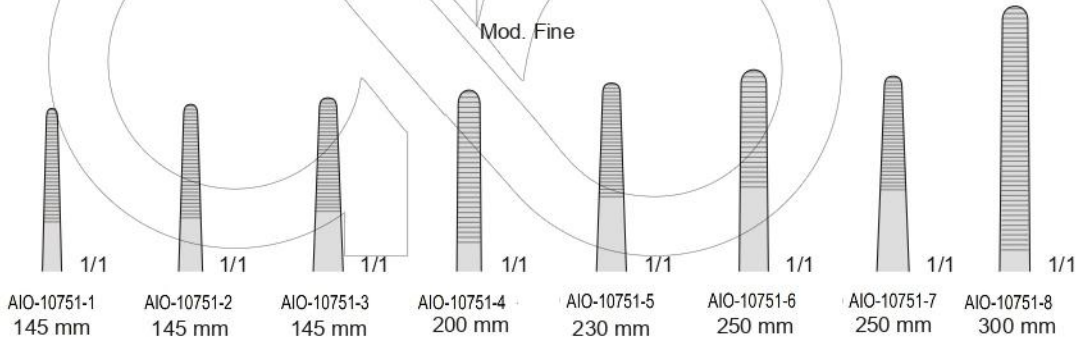



STILLE
04-610

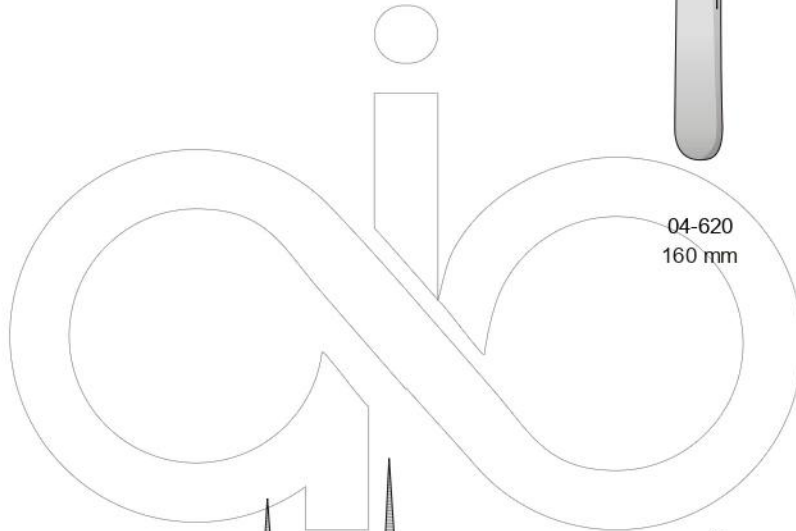
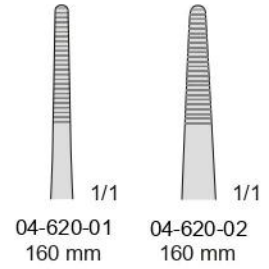
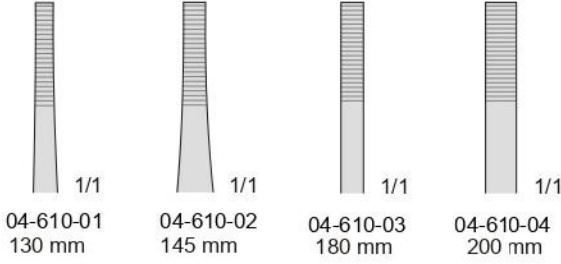

04-620
160 mm



04-630/640

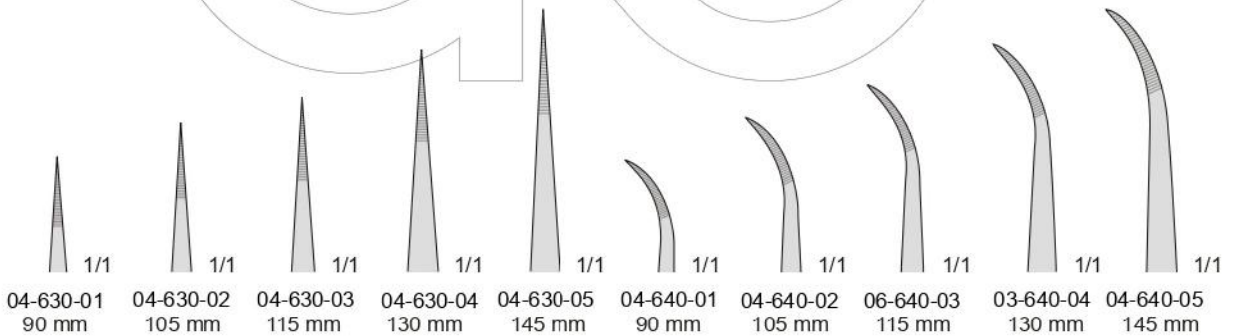

1 x 2 Denti - 1 x 2 Teeth - 1 x 2 Zähne - 1 x 2 Dents - 1 x 2 Dientes



Standard

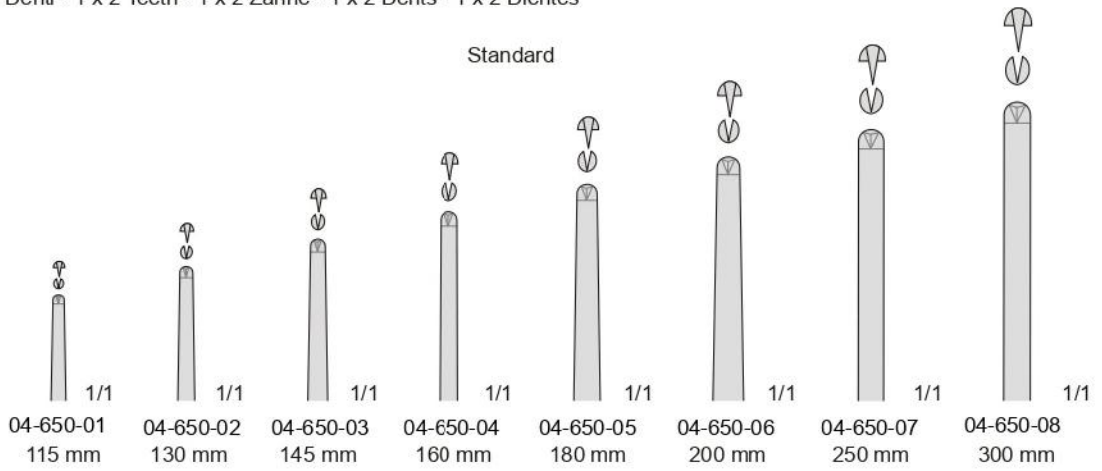

04-650

1 x 2 Denti - 1 x 2 Teeth - 1 x 2 Zähne - 1 x 2 Dents - 1 x 2 Dientes



Strette - Schmal - Narrow - Étroites - Estrechas

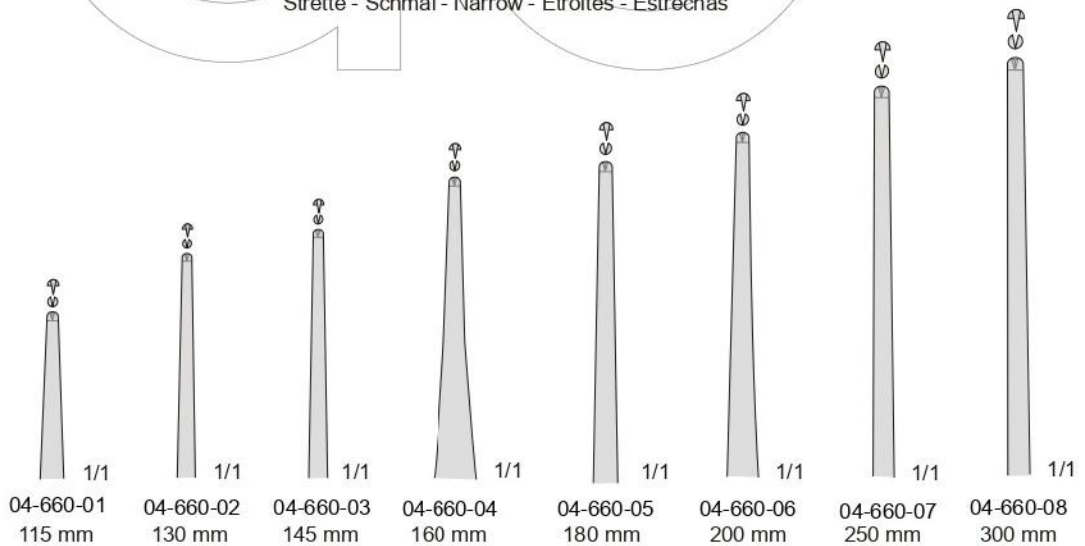

04-660

Strette - Schmal - Narrow - Étroites - Estrechas

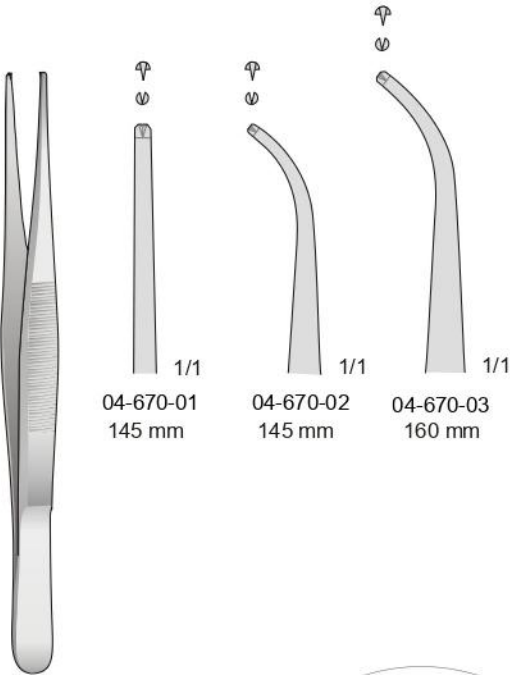

04-670-01
145 mm

04-670-02
145 mm

04-670-03
160 mm

Fine - Delicate - Fein - Fines - Finas

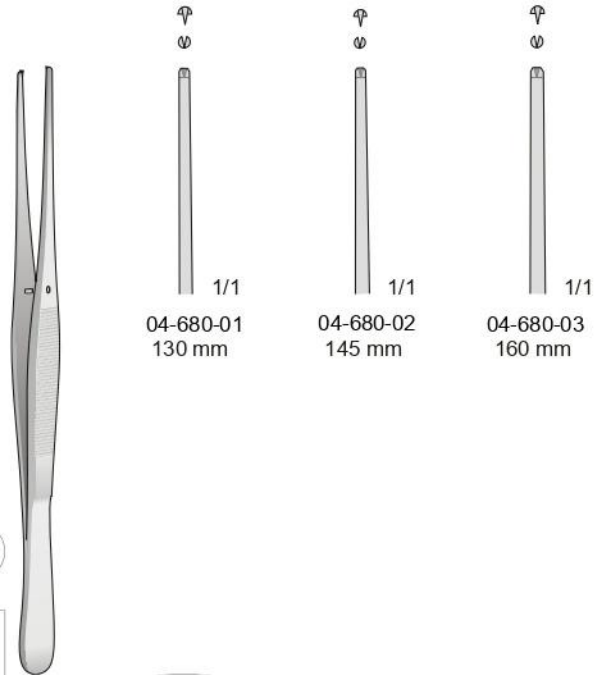

04-680-01
130 mm

04-680-02
145 mm

04-680-03
160 mm

04-690



POTTS-SMITH
04-690

1 x 2 Denti
1 x 2 Teeth
1 x 2 Zähne
1 x 2 Dents
1 x 2 Dientes

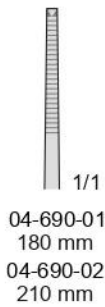

04-690-01
180 mm
04-690-02
210 mm

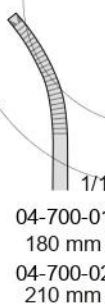

04-700-01
180 mm
04-700-02
210 mm

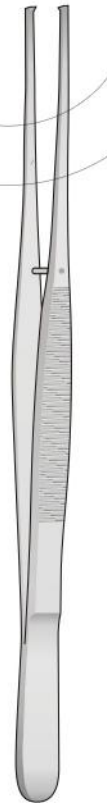

POTTS-SMITH
04-710

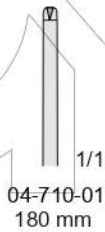

04-710-01
180 mm

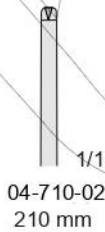

04-710-02
210 mm

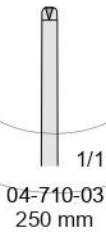

04-710-03
250 mm

04-680



SEMKEN
04-720
150 mm

1 x 2 Denti
1 x 2 Teeth
1 x 2 Zähne
1 x 2 Dents
1 x 2 Dientes



04-720-01
150 mm



04-720-02
150 mm

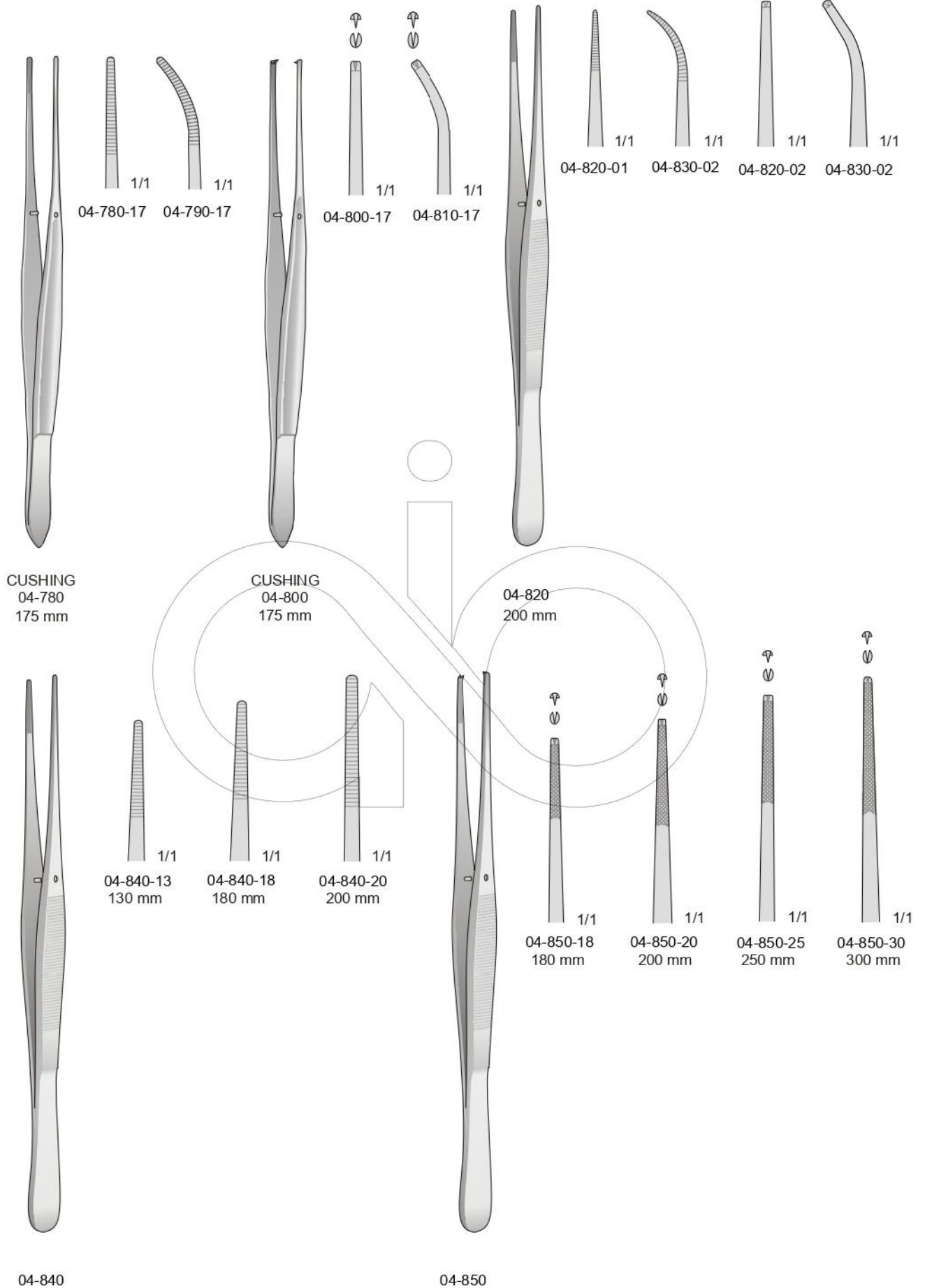



2 x 3 Denti - 2 x 3 Teeth - 2 x 3 Zähne
2 x 3 Dents - 2 x 3 Dientes



04-860



1/1

04-860-11
115 mm

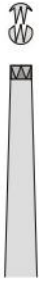

1/1

04-860-14
145 mm



1/1

04-860-16
160 mm



1/1

04-860-18
180 mm

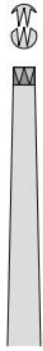

1/1

04-860-20
200 mm



3 x 4 Denti - 3 x 4 Teeth - 3 x 4 Zähne
3 x 4 Dents - 3 x 4 Dientes



04-870



1/1

04-870-14
145 mm



1/1

04-870-16
160 mm



1/1

04-870-20
200 mm



1/1

04-870-25
250 mm



4 x 5 Denti
4 x 5 Teeth
4 x 5 Zähne
4 x 5 Dents
4 x 5 Dientes



1/1

04-880-14
145 mm



1/1

04-880-16
160 mm



04-880

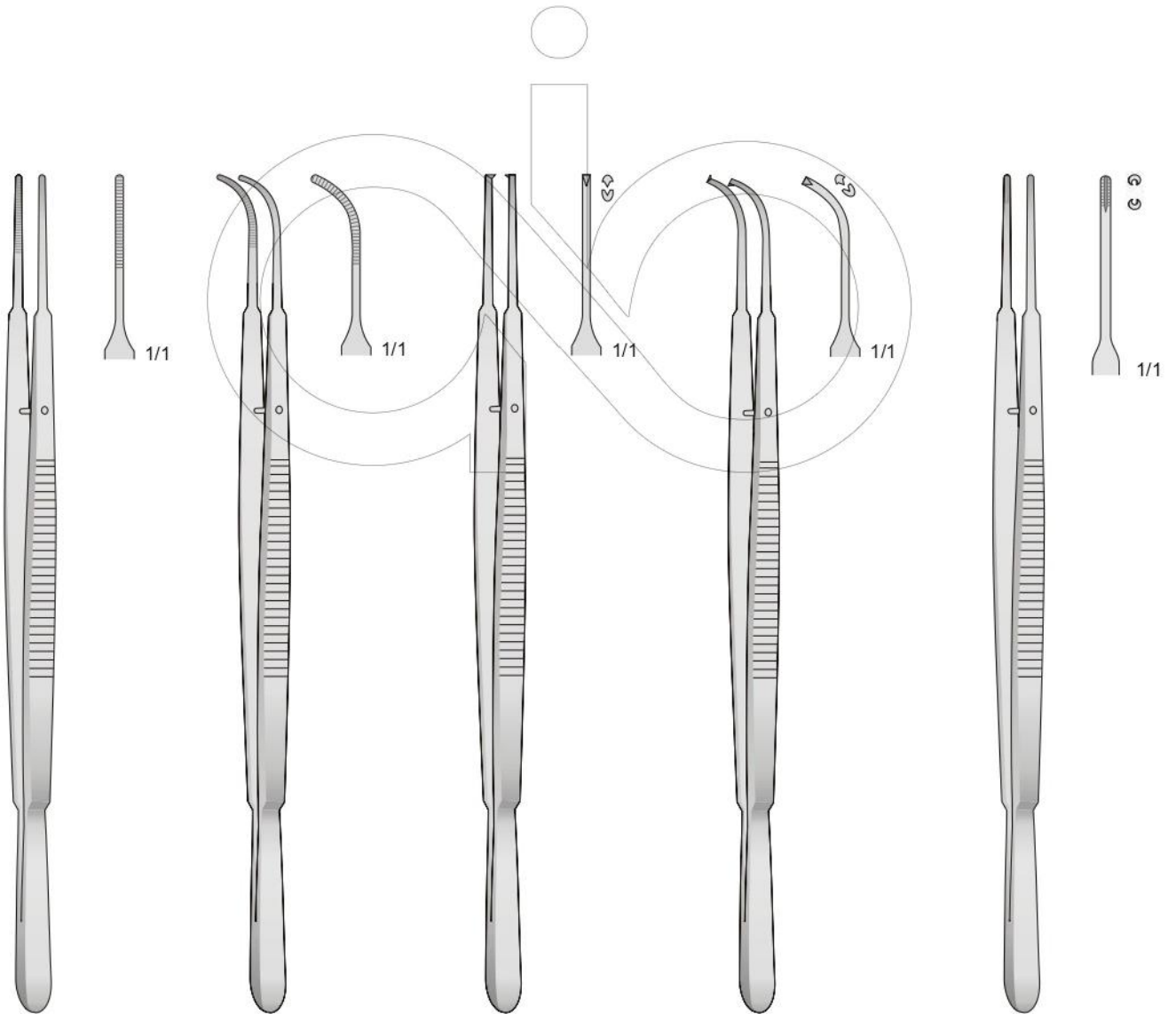

GERALD
04-890-18
180 mm

GERALD
04-900-18
180 mm

GERALD
04-910-18
180 mm

GERALD
04-920-18
180 mm

GERALD-BROWN
04-930-18
180 mm

Pinzette per vasi e per tumori
Pincers vasculaires et pour tumeurs

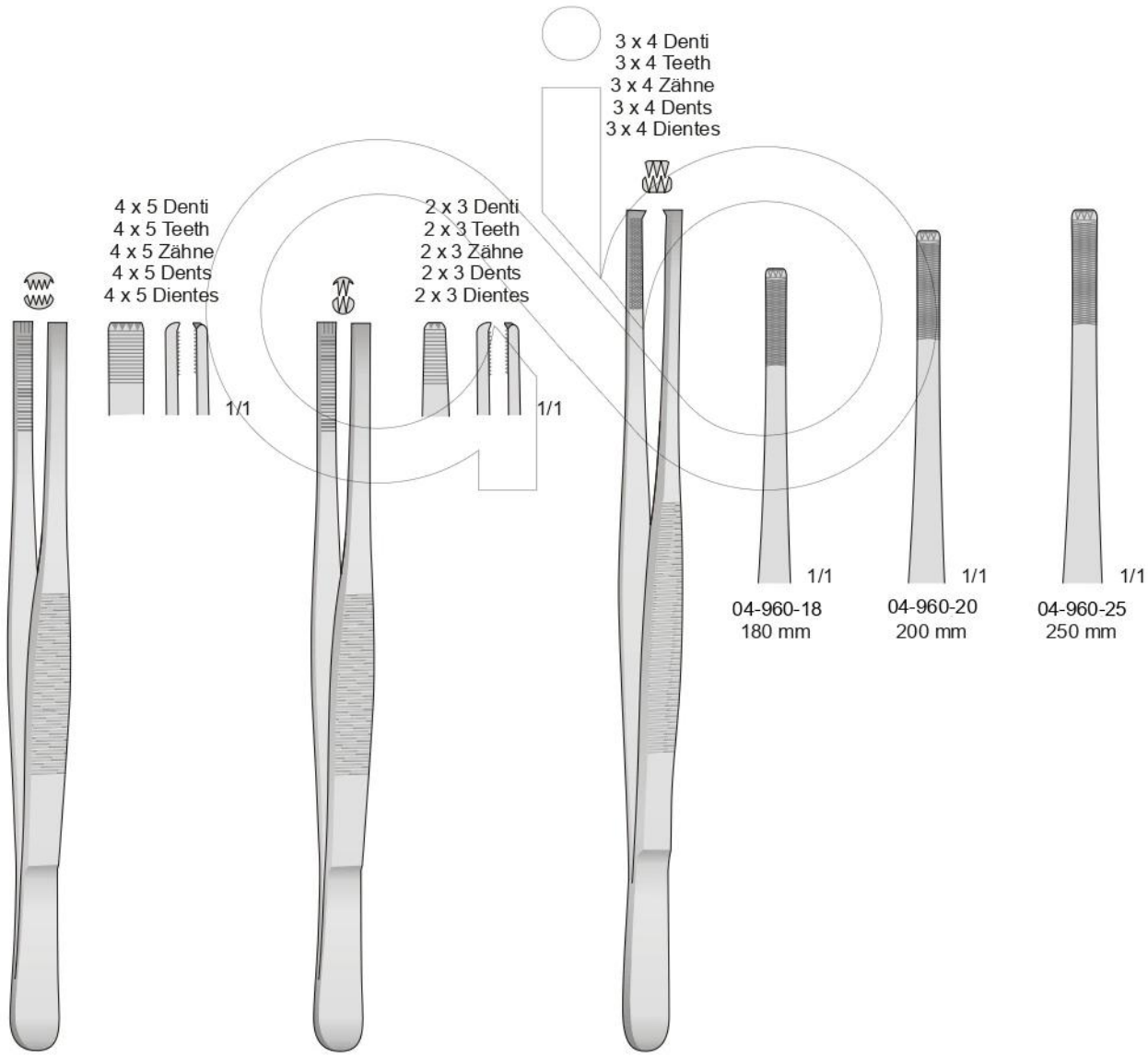

4 x 5 Denti
4 x 5 Teeth
4 x 5 Zähne
4 x 5 Dents
4 x 5 Dientes

2 x 3 Denti
2 x 3 Teeth
2 x 3 Zähne
2 x 3 Dents
2 x 3 Dientes

3 x 4 Denti
3 x 4 Teeth
3 x 4 Zähne
3 x 4 Dents
3 x 4 Dientes

04-960-18
180 mm

04-960-20
200 mm

04-960-25
250 mm

ADLERKREUTZ
04-940-15 - 150 mm
04-940-20 - 200 mm
04-940-25 - 250 mm

ADLERKREUTZ
04-950-15 - 150 mm
04-950-20 - 200 mm

STILLE-BARRAYA
04-960

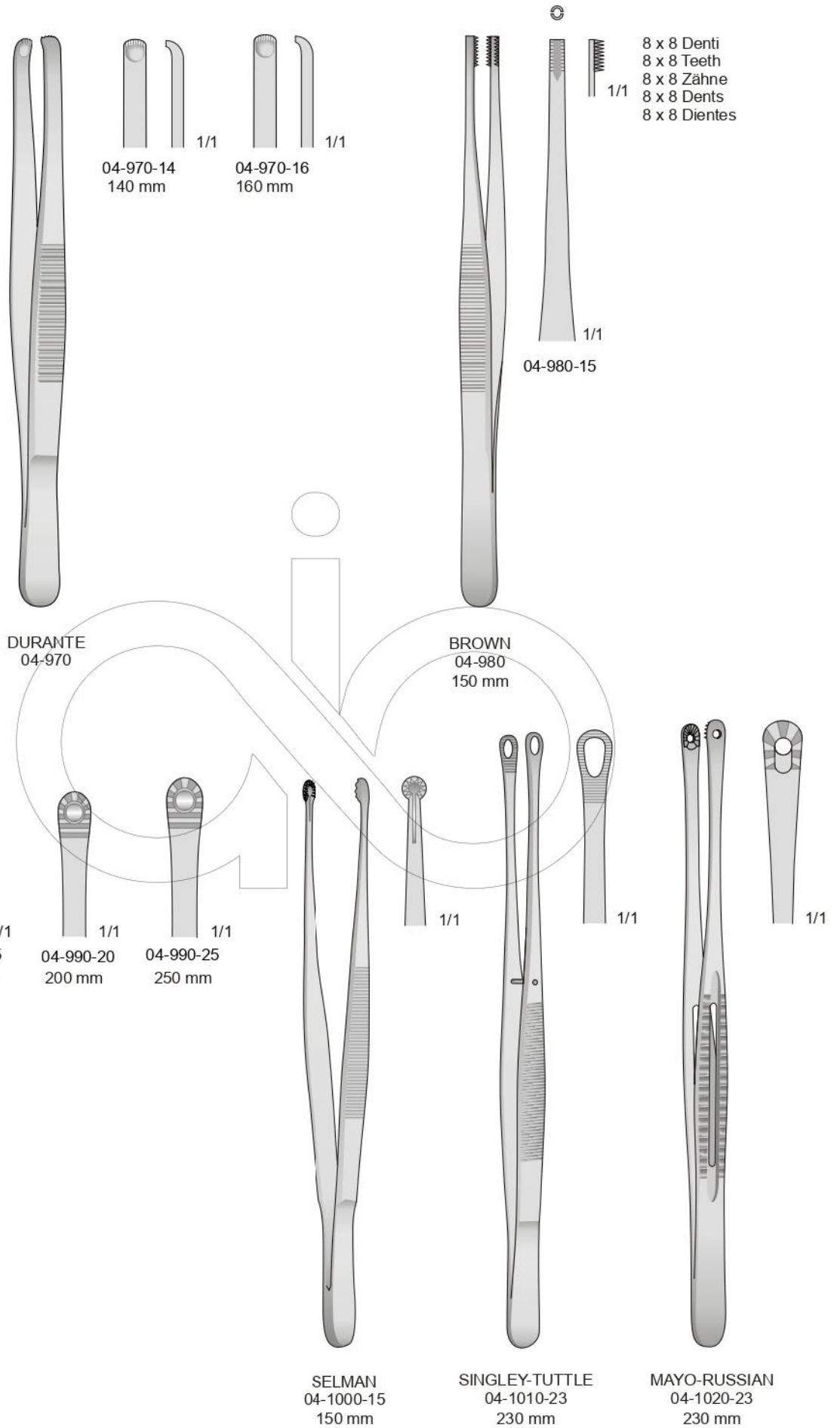

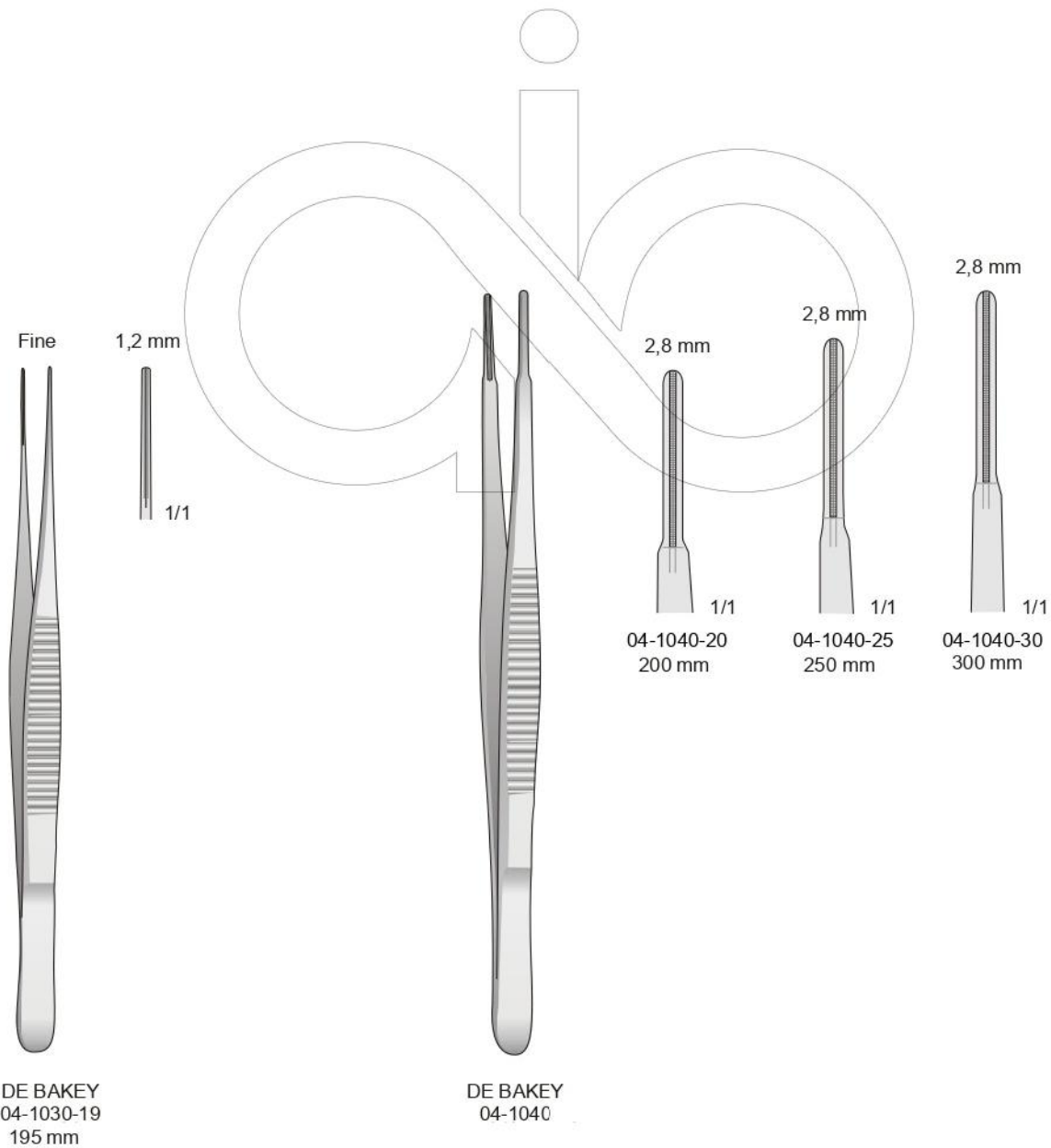

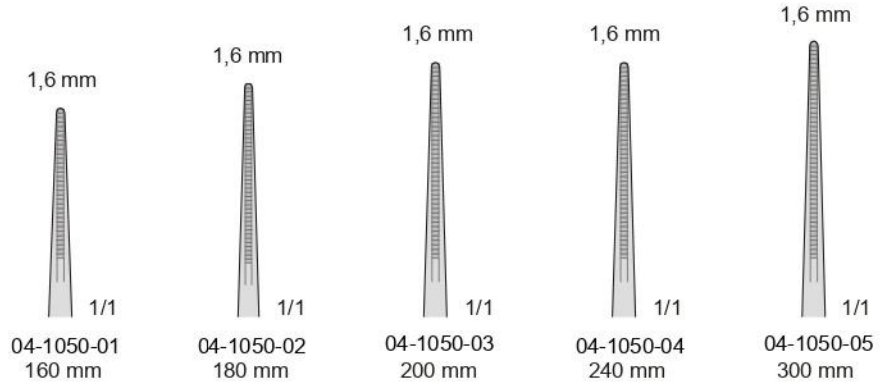

Pinzette atraumatiche
Non-traumatic vascular tissue forceps
Atraumatische pinzetten
Pincés atraumáticas
Pinzas atraumaticas



DE BAKEY
04-1050/1060

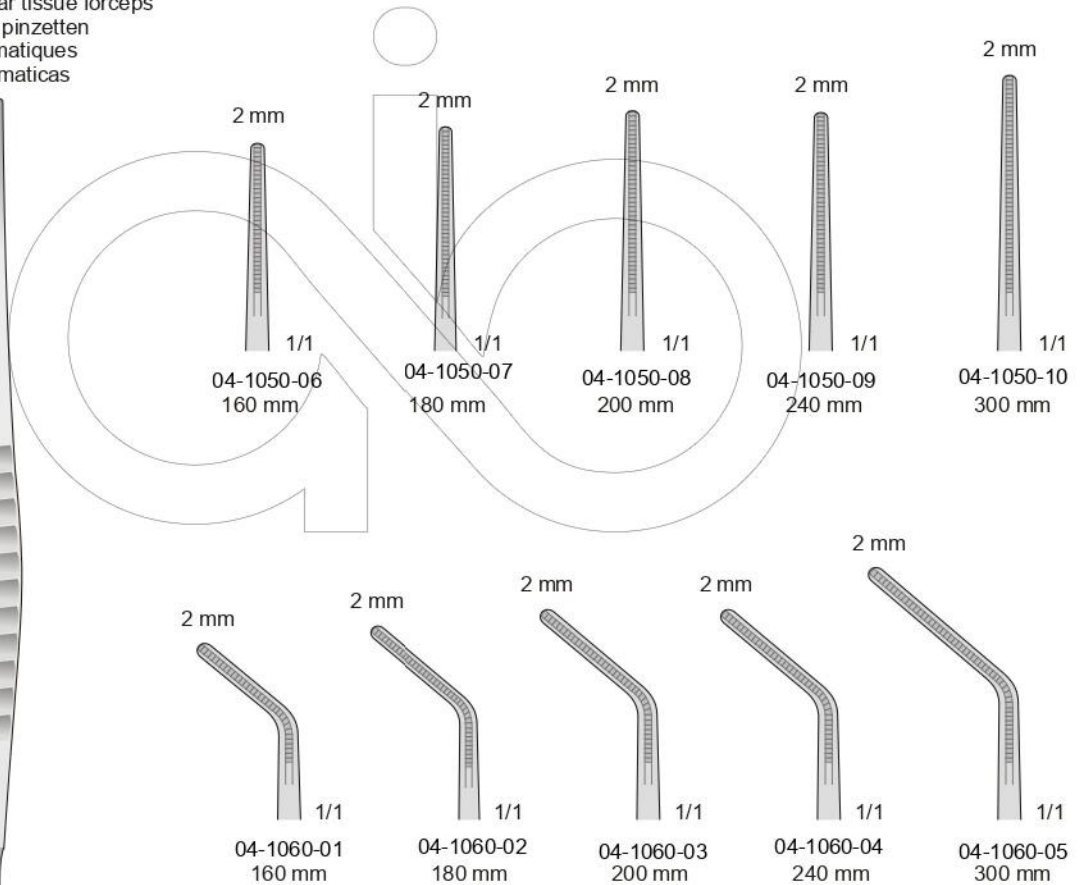

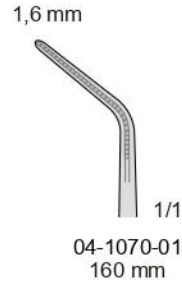

Pinzette atraumatiche
Atraumatische pinzetten
Atraumatic vascular tissue forceps
Pincés atraumáticas
Pinzas atraumáticas



DE BAKEY
04-1070/1080

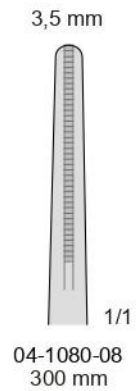
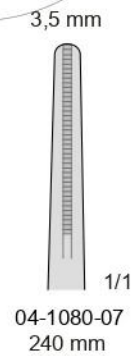
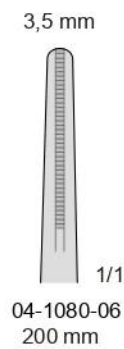
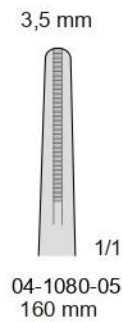
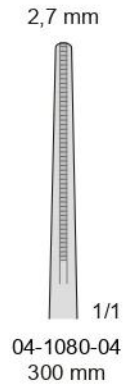
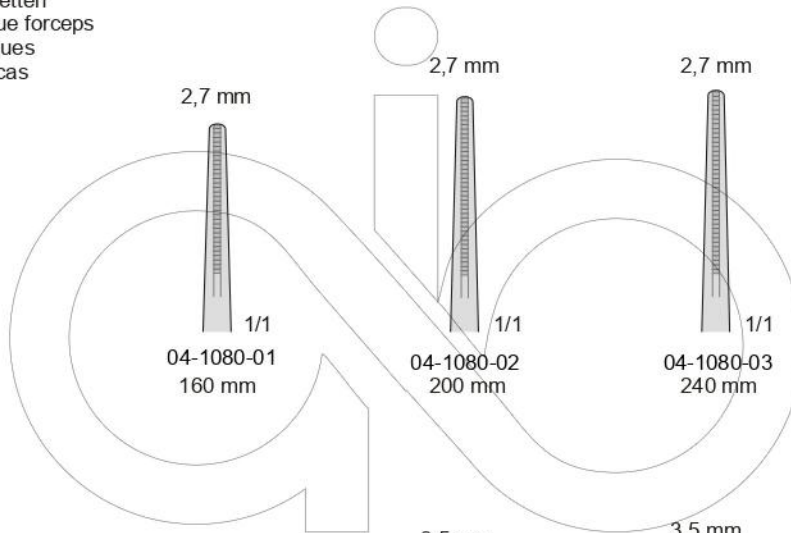

Pinze da Fissazione-oftalmica - Fixier und fasspinzetten
Fixation and Grasping forceps - Pinzas de fijación y de aprehensión

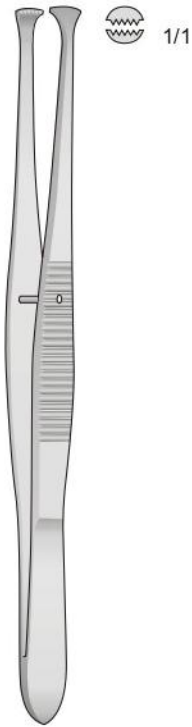

GRAEFE
04-1090-11
110 mm

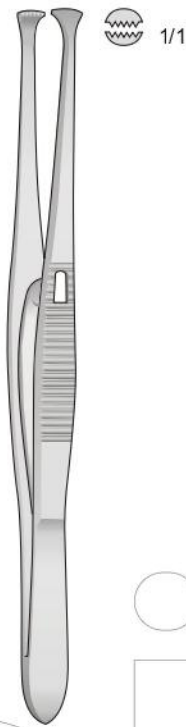

GRAEFE
04-1100-11
110 mm

Pinzetta-Columella
con stop



COTTLE
04-1110-10
100 mm

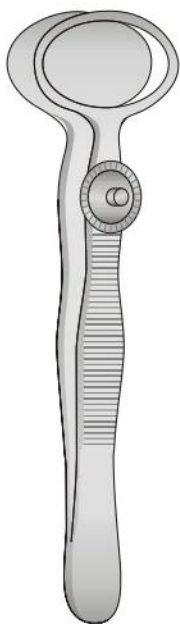
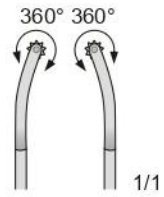

DESMARRES
04-1120
90 mm



04-1120-20
20 mm

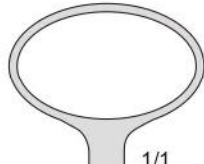

04-1020-26
26 mm



04-1120-31
31 mm

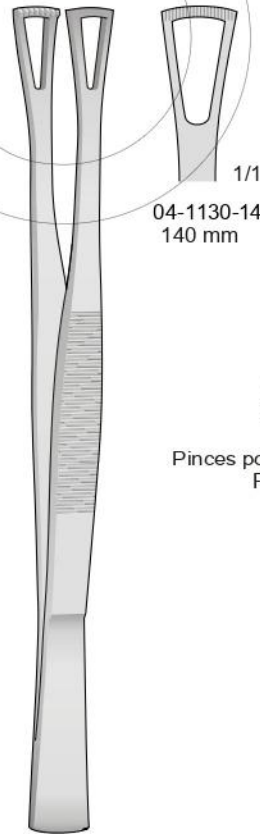

DUVAL
04-1130

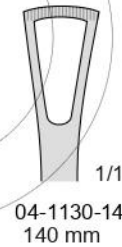

04-1130-14
140 mm

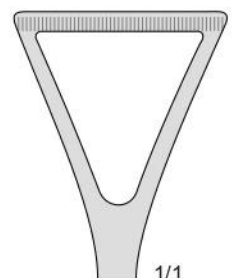

04-1130-20
200 mm

Pinze intestinali
Intestinal forceps
Darmpinzetten
Pinces pour préhension de l'intestin
Pinzas intestinales

Con punta al carburo di tungsteno - Tungsten-carbide forceps
Mit Hartmetalleinsätzen - Avec plaquettes en carbure de tungstène - Pinzas con tungsteno



ADSON
04-1140

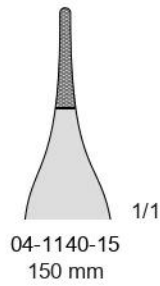
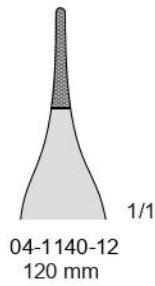

ADSON
04-1150

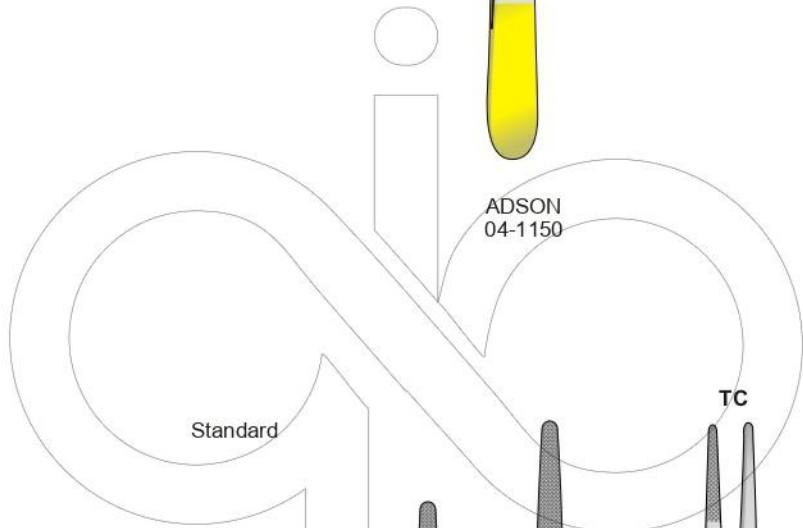
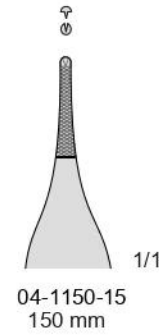
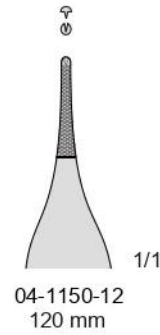

Standard



04-1160

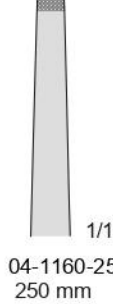
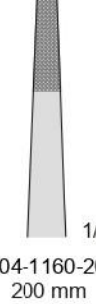
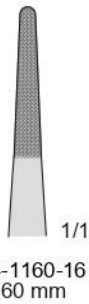

SEMKEN
04-1170



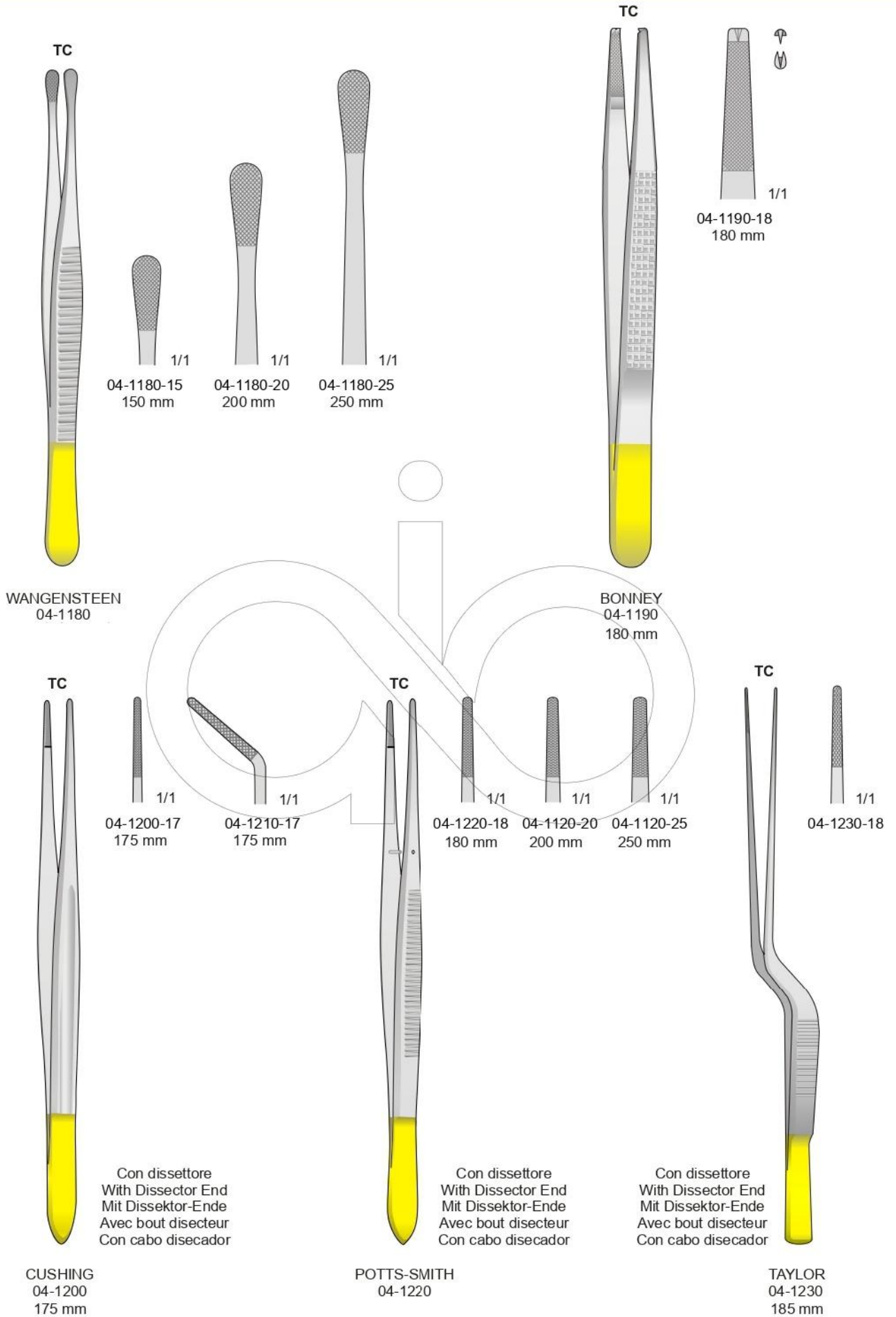

Con punta al carburo di tungsteno
Tungsten-carbide forceps
Mit Hartmetalleinsätzen
Avec plaquettes en carbure de tungstène
Pinzas con tungsteno

TC



DE BAKEY
04-1240-18
180 mm

TC



04-1250

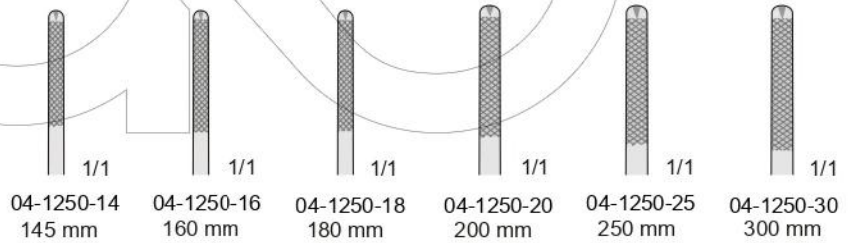
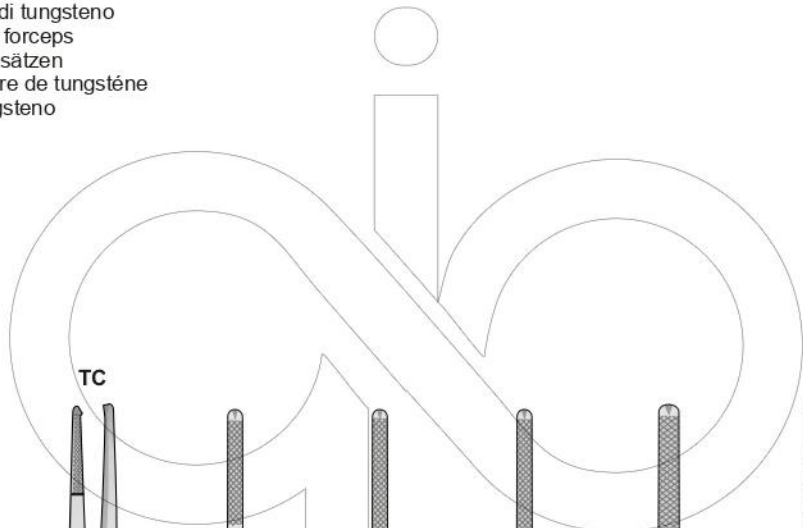

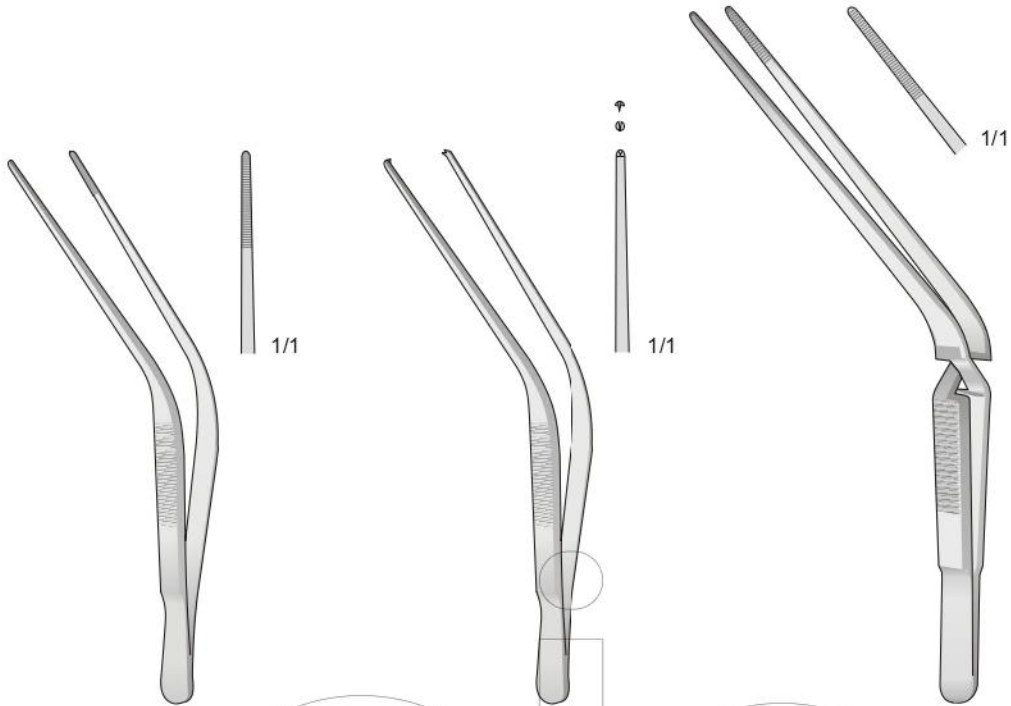

TROELTSCH
04-1260-11
110 mm

TROELTSCH
04-1270-11
110 mm

TROELTSCH
04-1280-13
130 mm

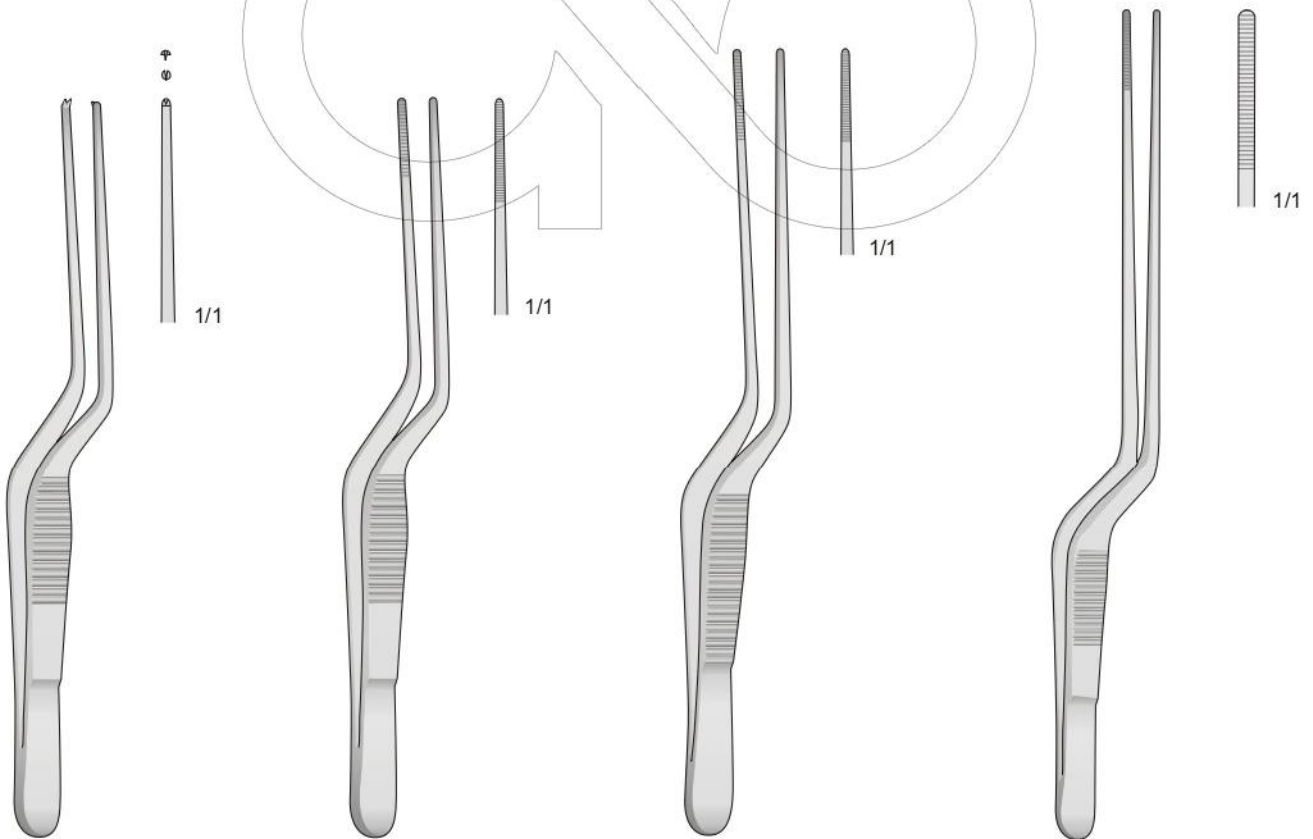

LUCAE
04-1290-14
140 mm

LUCAE
04-1300-14
140 mm

JANSEN
04-1310-16
160 mm

GRÜENWALD
04-1320-20
200 mm

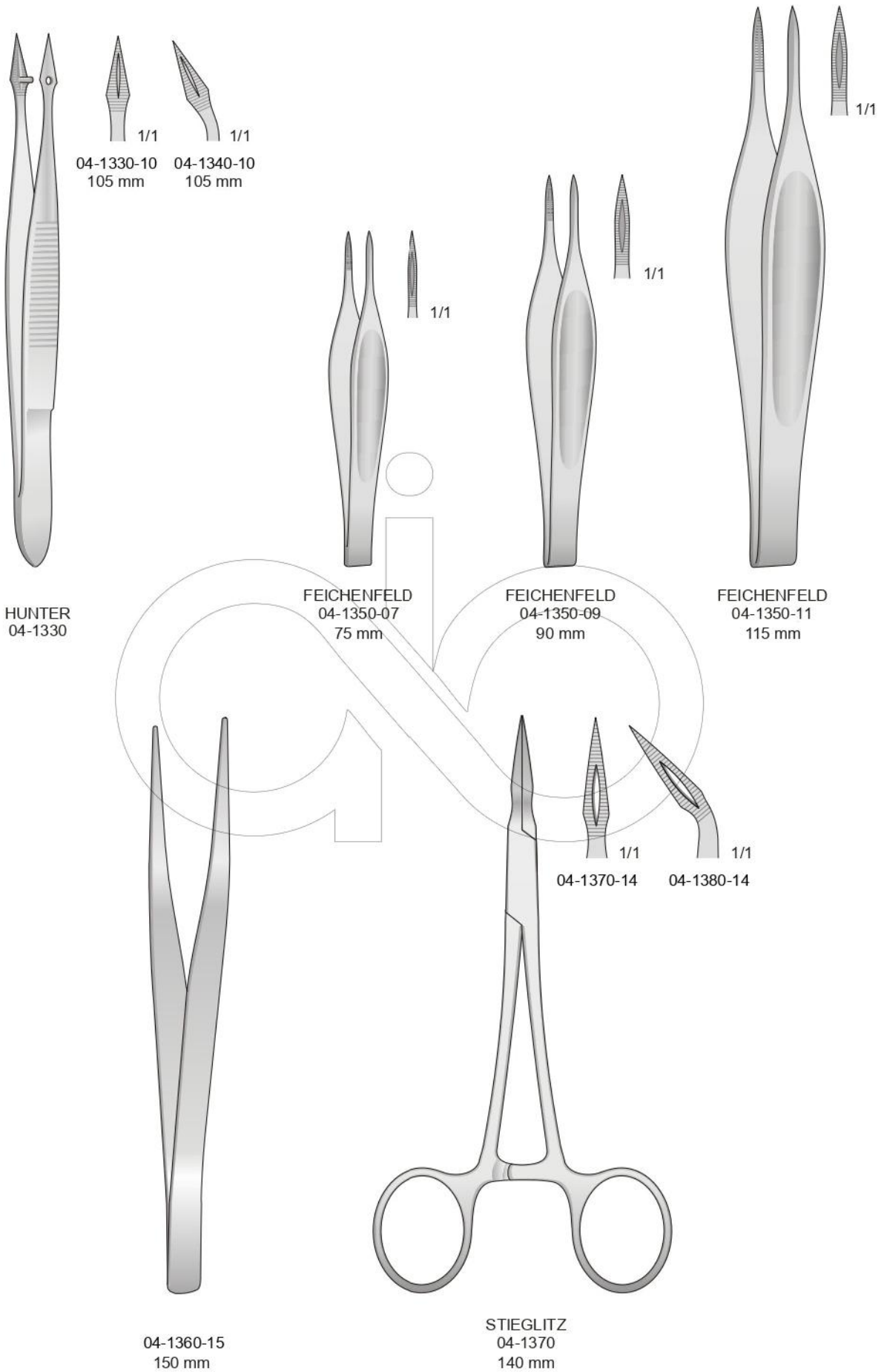

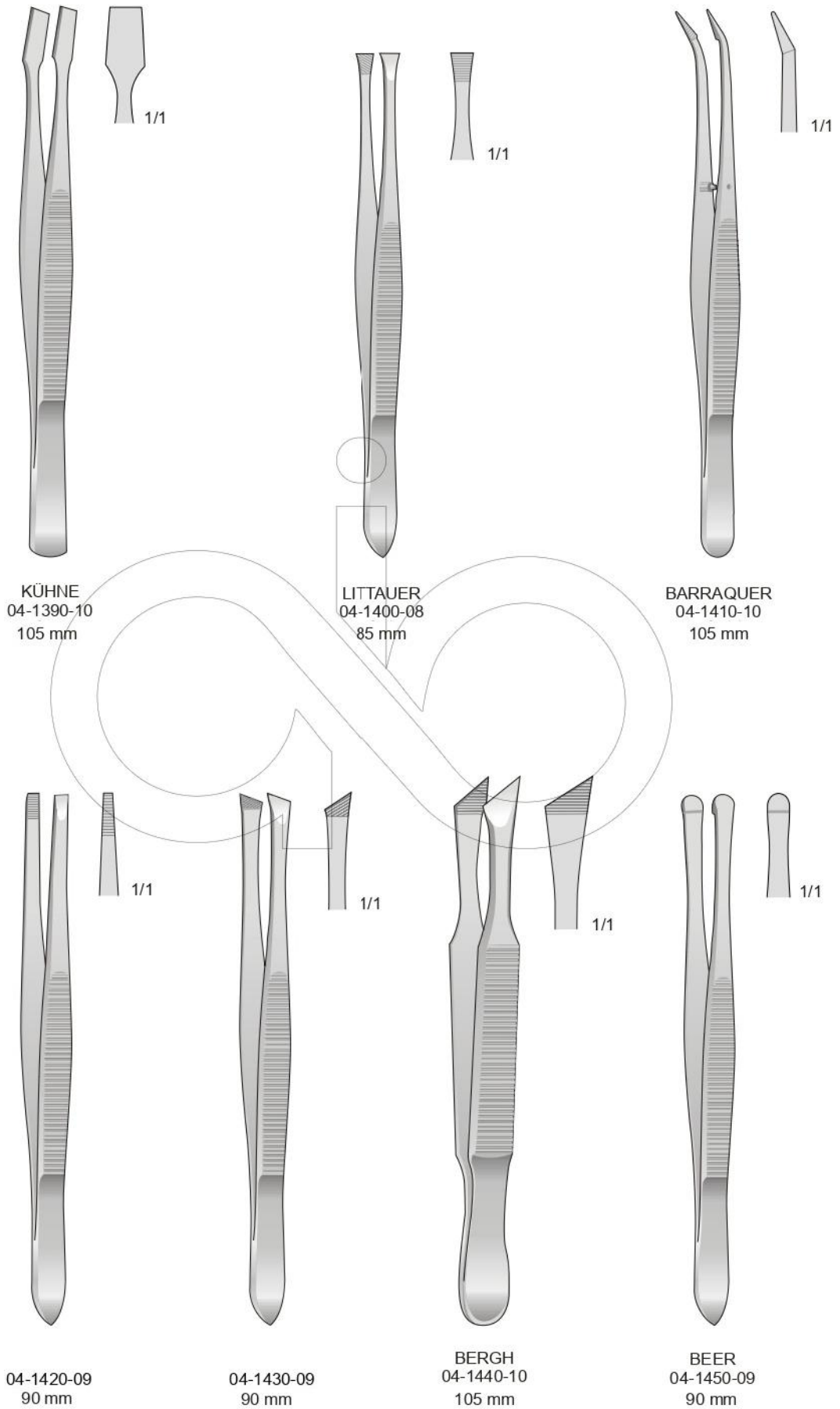



ALL IN ONE

SUPPLIES

Manufacturer & Exporter Of Surgical, Dental & Orthopedic Instruments.

+92-333-8740-629

info@aiosupplies.com | medisuraj@gmail.com

Bismillah Street, Kacha Shahab Pura, S.I.E. Sialkot Pakistan

www.aiosupplies.com



ISO 9001:2008

